

COBHAM

EXPLORER 540

User & integrator's manual

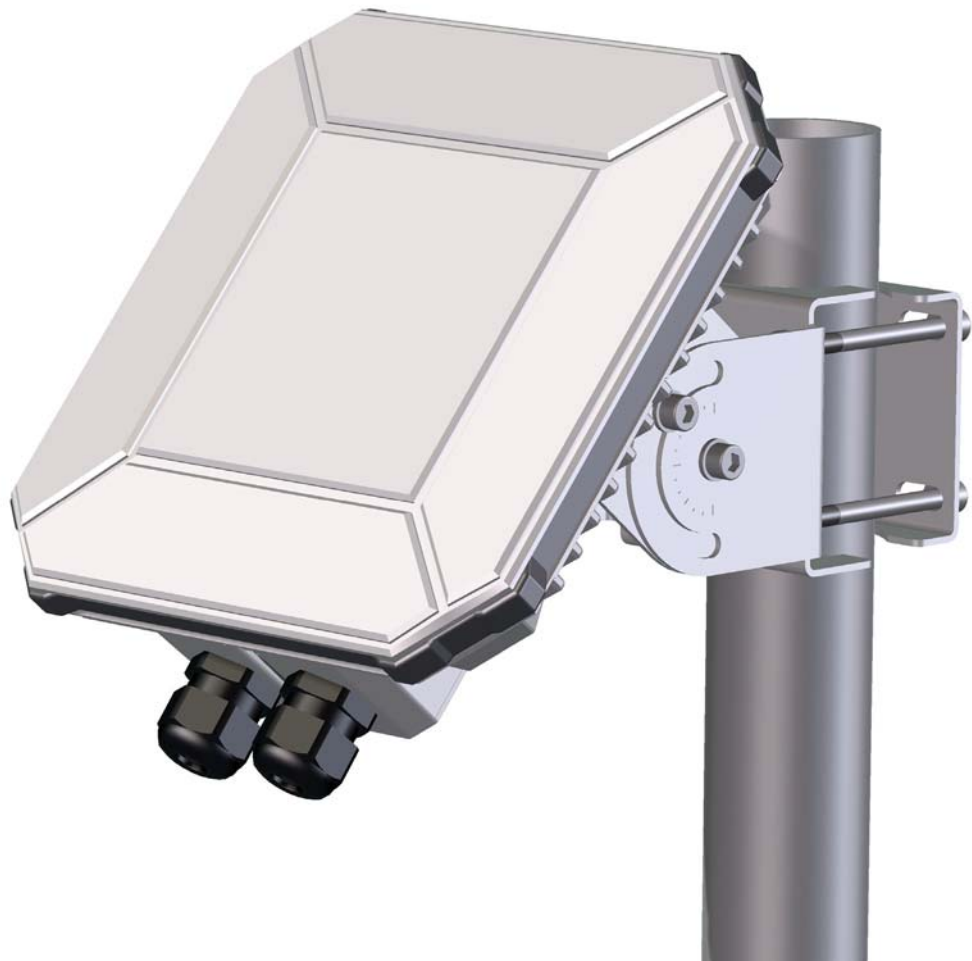

Document number: 98-148232-B

Release date: 26 April 2016

Disclaimer

Any responsibility or liability for loss or damage in connection with the use of this product and the accompanying documentation is disclaimed by Thrane & Thrane A/S. The information in this manual is provided for information purposes only, is subject to change without notice and may contain errors or inaccuracies. Manuals issued by Thrane & Thrane A/S are periodically revised and updated. Anyone relying on this information should acquire the most current version e.g. from www.cobham.com/satcom, **Service and support**, or from the distributor. Thrane & Thrane A/S is not responsible for the content or accuracy of any translations or reproductions, in whole or in part, of this manual from any other source. In the event of any discrepancies, the English version shall be the governing text.

Thrane & Thrane A/S is trading as Cobham SATCOM.

Copyright

© 2016 Thrane & Thrane A/S. All rights reserved.

Trademark acknowledgements

- **Inmarsat** is a registered trademark of the International Maritime Satellite Organisation (IMSO) and is licensed by IMSO to Inmarsat Limited and Inmarsat Ventures plc.
- Other product and company names mentioned in this manual may be trademarks or trade names of their respective owners.

Safety summary

The following general safety precautions must be observed during all phases of operation, service and repair of this equipment. Failure to comply with these precautions or with specific warnings elsewhere in this manual violates safety standards of design, manufacture and intended use of the equipment. Thrane & Thrane A/S assumes no liability for the customer's failure to comply with these requirements.

If the equipment is used in a manner not specified by the manufacturer, the protection may be impaired.

Keep away from live circuits

Operating personnel must not remove equipment covers, other than the cover for the interface enclosure. Component replacement and internal adjustment must be made by qualified maintenance personnel. Do not replace components with the power cable connected. Under certain conditions, dangerous voltages may exist even with the power cable removed. To avoid injuries, always disconnect power and discharge circuits before touching them.

Do not substitute parts or modify equipment

Because of the danger of introducing additional hazards, do not substitute parts or perform any unauthorized modification to the equipment.

Keep away from antenna front

This device emits radio frequency energy when switched on. To avoid injury, keep a minimum safety distance of 1 m from the antenna front when the EXPLORER 540 is on.



Garder à l'écart de l'avant de l'antenne

Le présent appareil émet des radiofréquences lors de son utilisation. Afin d'éviter tout risque pour la santé, une distance minimale de 1 m est nécessaire entre l'utilisateur et l'avant de l'EXPLORER 540.

Observe marked areas

Under extreme heat conditions do not touch areas of the EXPLORER 540 that are marked with this symbol, as it may result in injury.



Antenna safety instructions

**Use only manufacturer supplied antennas.
Antenna minimum safe distance: 1 m**

Antenna gain

Directional, with maximum gain of 11.25 dBi (with reference to isotropic).

The Federal Communications Commission has adopted a safety standard for human exposure to RF (Radio Frequency) energy which is below the OSHA (Occupational Safety and Health Act) limits.

Antenna mounting

The antenna supplied by the manufacturer must be located such that during radio transmission, no person or persons can come closer than the above indicated minimum safe distance to the front face of the antenna, i.e. 1 m.

L'antenne fournie par le fabricant doit être placée de telle sorte que, durant les transmissions radio, personne ni aucun groupe de personnes ne puisse s'approcher à une distance inférieure à la distance de sécurité minimal indiquée ci-dessus, c.-à-d., 1 m.

To comply with current FCC RF Exposure limits, the antenna must be installed at or exceeding the minimum safe distance shown above, and in accordance with the requirements of the antenna manufacturer or supplier.

Radiation warning



WARNING! Maintain a separation distance of at least 1 m from the front face of the antenna to a person.

You, as the qualified end-user of this radio device, must control the exposure conditions of bystanders to ensure the minimum separation distance (above) is maintained between the antenna and nearby persons, for satisfying RF Exposure compliance. The operation of this transmitter must satisfy the requirements of General Population/Uncontrolled Environment. Only use the terminal when persons are at least the minimum distance from the front face of the antenna.

About this manual

Intended readers

This manual is a user and integrator's manual for the EXPLORER 540. The manual is intended for anyone who is using or intends to use the EXPLORER 540, including system integrators. No specific skills are required to operate the EXPLORER 540. However, it is important that you observe all safety requirements listed in the **Safety summary** in the beginning of this manual, and operate the EXPLORER 540 according to the guidelines in this manual.

Related documents

The following documents are related to this manual and to the EXPLORER 540 system.

Title and description	Document number
EXPLORER 540 Installation guide (English)	98-148231
EXPLORER 540 Installation guide (German)	98-150246
EXPLORER 540 Installation guide (French)	98-150247
EXPLORER 540 Installation guide (Spanish)	98-150248
EXPLORER 540 Installation guide (Russian)	98-150249
EXPLORER 540 Installation guide (Japanese)	98-150250
EXPLORER 540 Installation guide (Chinese)	98-150251

Typography

In this manual, typography is used as indicated below:

Bold is used for the following purposes:

- To emphasize words.
Example: "Do **not** touch the antenna front during pointing".
- To indicate what the user should select in the user interface.
Example: "Select **Control panel** > **LAN** and click **Enable**".

Italic is used to emphasize the paragraph title in cross-references.

Example: "For further information, see *Connecting Cables* on page...".

Courier is used to indicate low level commands, e.g. AT commands.

Table of contents

Chapter 1 Introduction to EXPLORER 540

General description	1
Features and interfaces of the EXPLORER 540	2
Your EXPLORER 540 terminal	3
BGAN services	5
System overview	6

Chapter 2 To get started

To unpack the EXPLORER 540	7
SIM card	8
Cable connections	9
Fixed installation of the EXPLORER 540	10
To power the EXPLORER 540	10
Installation process	11
To access the web interface	14
M2M application examples	15

Chapter 3 Operation

Local or remote control	18
To access the terminal using AT commands	19
To access the terminal from a remote location	20
Security setup	27
To control data connections (PDP contexts)	29
Power-saving	31
Remote software upgrade	33
File transfer	34
Status of the EXPLORER 540	36
Control or status with GPIO pin 3	37

Chapter 4 Configuration with web interface

The web interface	39
-------------------------	----

To control data connections from web interface	42
To set up your data connection packages (BGAN M2M)	43
Status information	45
The Control panel	46
To restart the installation process	47
To use the logs	48
Terminal settings	49
Port forwarding	53
To manage connected devices (Traffic control)	54
To set up tracking	57
Support features	59
Advanced settings	62
To enter the SIM PIN in the web interface	74

Chapter 5 Maintenance and troubleshooting

Support	75
Software update	76
Reset button	77
Maintenance	78
Troubleshooting	78
Log files	86
To view extended status	86
To reset the administrator password	87
Help desk	87
List of reserved IP subnets	88

App. A Technical specifications

General specifications	89
Interfaces specifications	90
Built-in BGAN antenna	92
Outline drawing	93

App. B	Command reference	
	SMS remote commands	95
	AT commands	99
App. C	BGAN non-M2M functions	
	To control data connections from web interface (BGAN)	108
	To set up data connections	110
	To make phone calls over BGAN (not M2M version)	111
	To manage VoIP phones or smartphones	114
App. D	Conformity	
	CE (R&TTE)	115
	IC	115
	FCC	115
	Japanese Radio Law and Japanese Telecommunications Business Law Compliance.	116
Glossary	118
Index	121

Introduction to EXPLORER 540

General description

The EXPLORER 540 is a small and light BGAN M2M terminal. The durable casing and a dust and water resistant design makes the EXPLORER 540 the perfect choice for any kind of fixed outside installation.

Depending on your airtime subscription, the EXPLORER 540 either operates as an M2M (machine-to-machine) terminal or as a standard class 2 terminal.



Features and interfaces of the EXPLORER 540

Features

- M2M or standard class 2, depending on airtime subscription (SIM card)
- Automatic installation function
- Standard data up to 464/448 kbps (download/upload)
- Remote management
- SMS for remote management
- Power save functions with various “wake on” methods (timer or input pin)
- Software upgrade and file transfer over-the-air
- Connectivity “watchdog” function (Link monitoring)
- Automatic context activation
- For the **M2M** version only:
 - Inmarsat M2M Access Platform
 - Access to Inmarsat FTP server for firmware upgrade
- For the **non-M2M** version: only
 - Streaming data rates of 32, 64 and 128 kbps
 - Voice over IP (Standard voice 4 kbps AMBE+2 codec or Premium voice 3.1 kHz audio 64 kbps)
- IP66 protection
- Built-in web interface allowing you to manage connections and customize the terminal to your specific needs, using a computer
- Support for GPS, GLONASS and BeiDou navigation systems

Interfaces

- LAN interface with Power over Ethernet (PoE) input
- I/O ports for control of power save mode and for remote control/status
- Power input from:
 - PoE+ (IEEE 802.3at type 2 class 4, 25 W) or
 - separate DC power source, e.g. a battery (max. range 10.5-32 VDC)

Approvals/certificates

Country	Approval / certificate
EU	CE
US	FCC
Canada	IC
Australia / New Zealand	RCM
Russia	Type approval certificate in the field of communications
Japan	Radio Law
International	GMPCS
International	C1D2
International	Inmarsat Class 2 Type Approved and BGAN M2M Certified

Your EXPLORER 540 terminal

EXPLORER 540 overview

The EXPLORER 540 is a small, compact unit comprising transceiver and antenna in one unit.

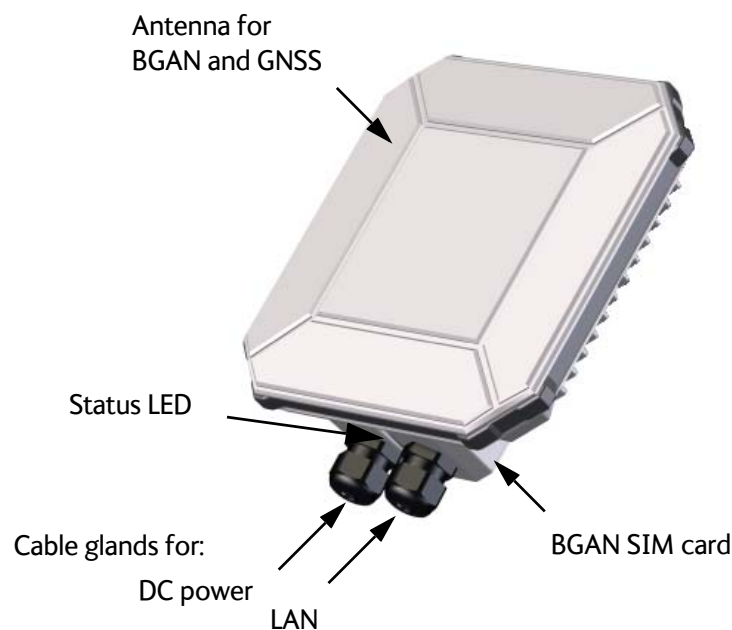

User interfaces

The **web interface** is a built-in web interface for easy configuration. The web interface is accessed from a computer connected to the EXPLORER 540, using an Internet browser. No installation of software is needed on the computer. For further information on the web interface, see *The web interface* on page 39.

With **AT commands** you can configure and control the EXPLORER 540 from a computer using a Telnet session, or from connected equipment, e.g. in M2M applications. For further details see *To access the terminal using AT commands* on page 19.

With **SMS commands** you can configure and control the EXPLORER 540 remotely. For details, see *Remote access with SMS* on page 20.

The distributors may have their own Graphical User Interface, which could be built on e.g. Inmarsat's M2M API (M2MAP) or similar. Contact your distributor for information.

Antenna

The plastic part of the EXPLORER 540 holds the antenna part comprising:

- GNSS (Global Navigation Satellite System) antenna supporting GPS, GLONASS and BeiDou.
- BGAN antenna.

SIM card

The EXPLORER 540 requires a SIM card to go online with BGAN. Without a SIM card you can still configure the terminal, but you cannot make calls nor access the internet.

Your SIM card determines whether your EXPLORER 540 is operating as an M2M terminal or as a standard class 2 terminal.

SIM lock: The supplier may have locked the SIM card to a specific provider. For further information, contact your supplier.

BGAN services

The Inmarsat BGAN services are based on the BGAN I4 geostationary satellites and the Alphasat satellite. The map below shows the coverage area.

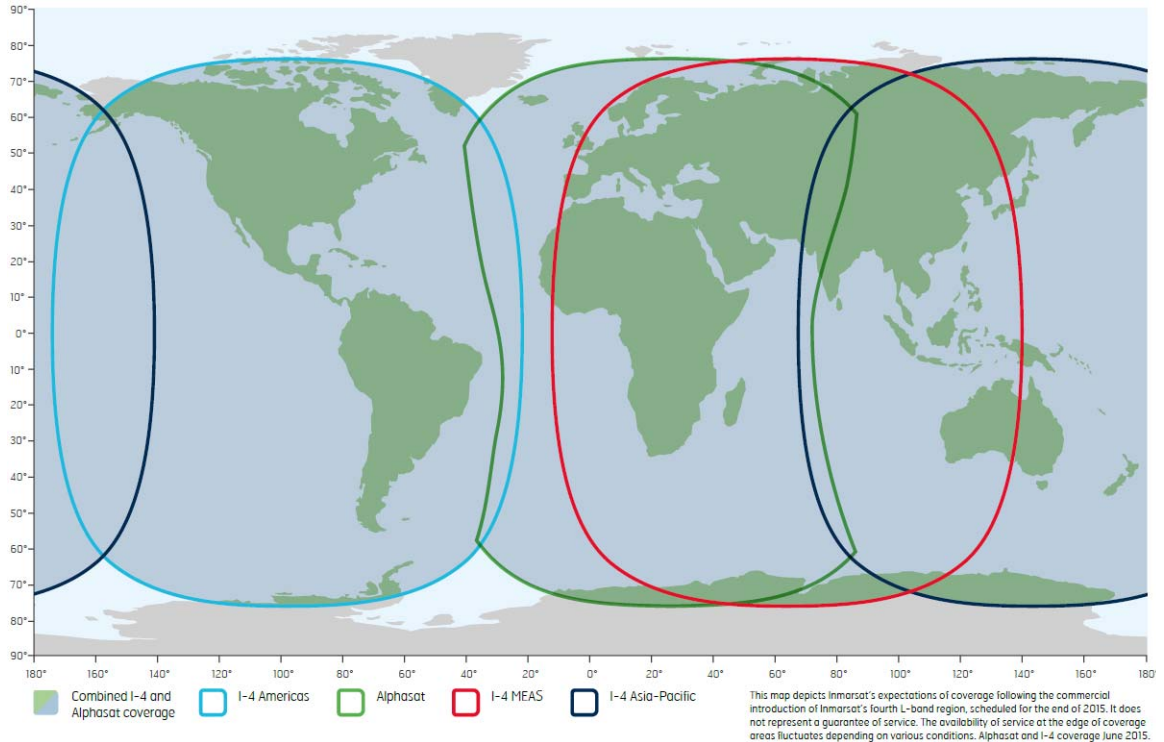

Note

The services available depend on the SIM card installed in the EXPLORER 540. You can have A BGAN M2M subscription or a standard class 2 subscription.

BGAN M2M services

BGAN M2M gives you a data connection to remote equipment and applications. With a BGAN M2M SIM card you have the following data capability:

- Standard data (background and interactive) up to 464 kbps/448 kbps.
- SMS for remote management.

Not supported: Streaming and voice calls.

Standard class 2 services

With a standard Class 2 SIM card you have the following data capabilities:

- Standard data (background and interactive) up to 464 kbps/448 kbps.
- Streaming data rates of 32, 64 and 128 kbps.

Via the EXPLORER 540 LAN interface, a SIP client (in a phone or M2M equipment) has the following voice capabilities:

- Standard voice 4 kbps AMBE+2 codec

- Premium voice 3.1 kHz audio 64 kbps

Additionally:

- SMS for remote management

For details about non-M2M functions, see *BGAN non-M2M functions* on page 108.

System overview

Power supply and additional equipment

There is one LAN interface and one DC power input on the EXPLORER 540.

Note The EXPLORER 540 works as a Powered Device (PD), that is it may be powered by PoE, but it does not supply PoE.

Depending on your configuration, you may have to use a PoE switch or a PoE injector connected to the LAN interface or a battery connected to the DC input in order to provide power to the EXPLORER 540. For examples, see *M2M application examples* on page 15. You may also need to provide a switch to be able to accommodate more than one LAN connection, e.g. for local access to the web interface during installation or service.

M2M overview, example

In the example below, the M2M system has a built-in PoE switch, providing the power to the EXPLORER 540 together with the M2M communication through the LAN interface.

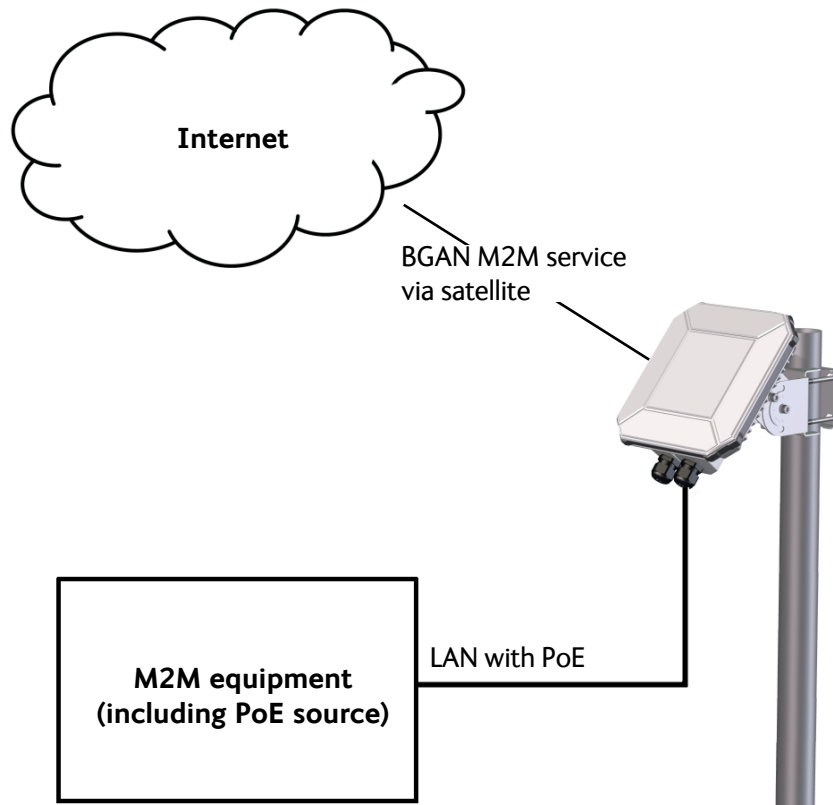

To get started

This chapter describes:

- *To unpack the EXPLORER 540*
- *SIM card*
- *Cable connections*
- *Fixed installation of the EXPLORER 540*
- *To power the EXPLORER 540*
- *Installation process*
- *To access the web interface*
- *M2M application examples*

To unpack the EXPLORER 540

Initial inspection

Inspect the shipping carton immediately upon receipt for evidence of damage during transport. If the shipping carton is severely damaged or water stained, request that the carrier's agent be present when opening the carton. Save the carton packing material for future use.



WARNING! To avoid electric shock, do not apply power to the system if there is any sign of shipping damage to any part of the front or rear panel or the outer cover. Read the safety summary at the front of this manual before installing or operating the system.

After unpacking the system, inspect it thoroughly for hidden damage and loose components or fittings. If the contents are incomplete, if there is mechanical damage or defect, or if the system does not work properly, notify your dealer.

What's in the delivery

The following items are included in the delivery:

- EXPLORER 540 terminal
- Pole mount kit
- 2 Cable glands and 1 Blind plug
- Torx bit for mounting/dismounting the cover for the interface enclosure
- Installation guide

SIM card

The SIM card determines whether the terminal operates as an M2M terminal or a standard BGAN class 2 terminal.

Important | Do not insert or remove the SIM card while the EXPLORER 540 is powered!

You insert the SIM card before installing the EXPLORER 540. The picture below shows the location of the SIM card holder, in the interface enclosure at the back of the terminal.



For details on how to insert the SIM card, see the installation guide.

Cable connections

There are no external connectors on the EXPLORER 540. All cable connections on the EXPLORER 540 are made during installation.

Remove the small cover at the back of the terminal and connect the cables to the relevant terminals or connectors. Two cable glands with gaskets are provided for the cables.

See *Interfaces specifications* on page 90 for specifications and pin-out for the interfaces.

See the section below for instructions specific to the DC input.

See the installation guide for details on how to connect cables in the EXPLORER 540.

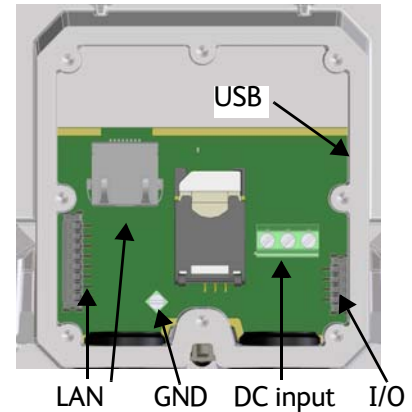

Instructions for DC input

Requirements

Observe the following requirements for connecting to the DC input:

- Power supply: Use only fused or current limiting power supply.
- Cable requirements:
 - Wire size: 1.5 mm²
 - Temperature rating: Min. 105 °C
 - Max. length: 12 m at 12 VDC, 200 m at 24 VDC
 - UV resistant cable

To connect to the DC input

Use a flat blade screw driver (max. 3.5 mm wide) to unscrew and fasten the screw terminals. Do as follows:

1. Lead the cable through the cable gasket at the DC input.



2. Insert the positive wire into the terminal marked 1-DCIN+ in the DC terminal block and tighten the screw.
3. Insert the negative wire into the terminal marked 2-DCIN- in the DC terminal block and tighten the screw.
4. If the DC cable is shielded, insert the end of the shield into the terminal marked 3-GND in the DC terminal block and tighten the screw.
5. Tighten the cable gland.

Fixed installation of the EXPLORER 540

To install the EXPLORER 540 in a fixed installation, use the pole mount kit included in the delivery.



For details on how to install the EXPLORER 540, see the included installation guide.

Important Make sure all cables are connected and the *Installation process for satellite operation* is completed before you fasten the EXPLORER 540 in your fixed installation.

To power the EXPLORER 540

The EXPLORER 540 has no power switch, but is automatically switched on when power is applied to the DC input or the LAN interface.

Use one of the following power sources (connected at installation, see the Installation guide):

- PoE+ via the LAN interface
- 12 or 24 VDC nominal, e.g. from a battery (absolute maximum rating 10.5-32 VDC)

Installation process

Physical installation

See also the supplied Installation guide.

A pole mount kit is included in the delivery. To mount the EXPLORER 540 on a pole, do as follows:

1. Attach the base of the pole mount bracket to the EXPLORER 540 using the included Hex L key on the 4 screws. Caution! Max. length of the screws is 9 mm! Longer screws can damage the EXPLORER 540.
2. Unscrew two of the long screws from the pole mount kit to leave one side open for the pole.
3. Place the pole mount kit with the EXPLORER 540 around the pole as shown.
4. Remount the two remaining long screws. Do not tighten the screws completely until you have pointed the antenna.

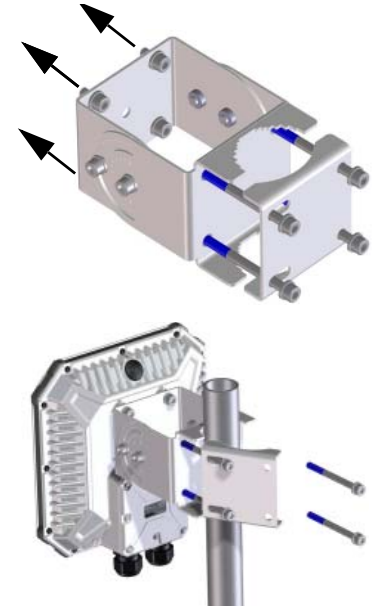

Pointing

Before pointing the antenna you can use the coverage map below to find your approximate location in relation to the satellites. Pointing is part of the Installation procedure described in the next section.

The Inmarsat satellites are positioned above the equator, at the centre of each “footprint”.

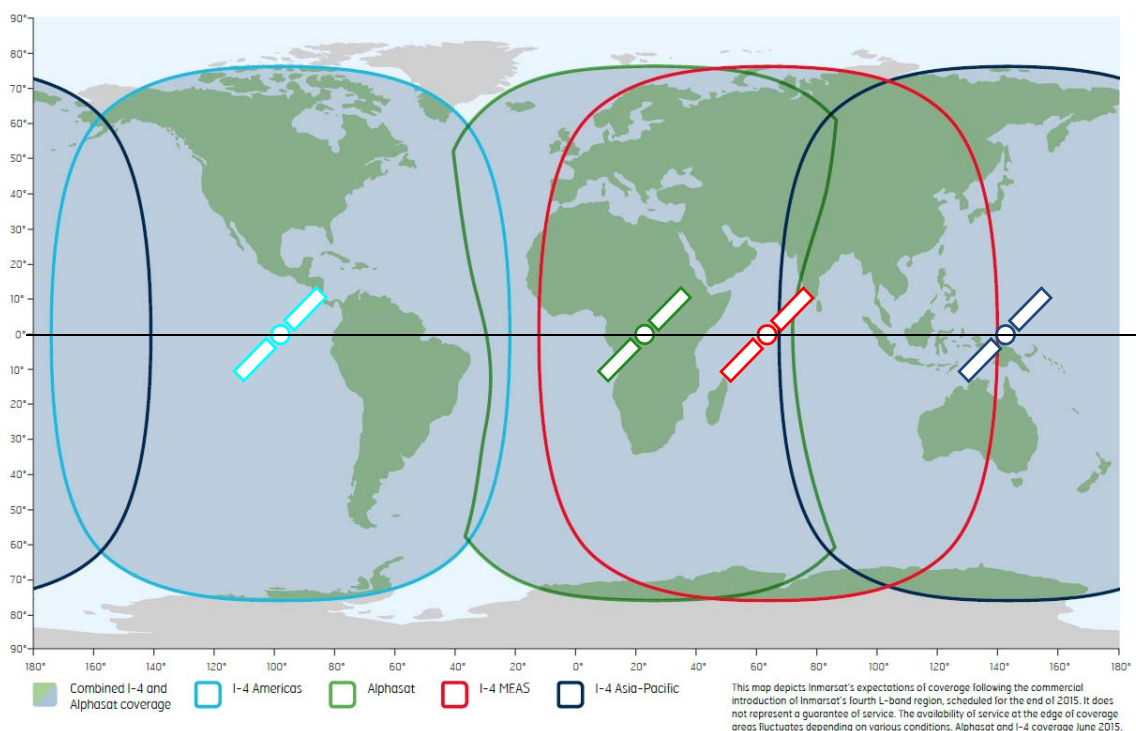

Installation process for satellite operation

Note Normally you are not required to enter a PIN code for the BGAN service, because the SIM PIN is either disabled or set up for automatic validation. However, if the PIN is enabled and not set up for auto validation, you have to enter the PIN before you can access the BGAN network. For details, see *To enter the SIM PIN in the web interface* on page 74.

The installation process starts up automatically when you apply power to the EXPLORER 540. The process is as follows:

1. Apply power to the EXPLORER 540 from a separate power supply or from a PoE source. The light indicator between the two cable glands shows the status during startup.¹
 - Green flashing rapidly: Starting up
 - Yellow flashing: BGAN pointing
2. When the indicator flashes yellow and you hear the pointing sound, you can start pointing the antenna.
3. Turn and tilt the EXPLORER 540 until you have obtained the highest possible signal strength (when the pointing sound is continuous you have the optimum signal, see the next section *Audio assisted pointing*).

Light indicator

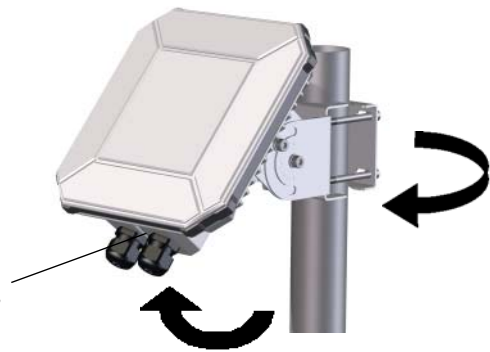

4. Tighten the screws to fix the EXPLORER 540 in the pointed position.

When the signal has been stable for about 20 seconds the pointing procedure automatically ends, and the terminal attempts to register on the network and verify the satellite connection (indicator flashing green).



CAUTION! When the connection is established, keep the minimum safety distance of **1 m from the antenna front face**. The antenna radiates microwave power as soon as the pointing procedure is completed.

5. When installation is completed successfully, the light indicator turns steady green and then, after a few minutes, the light goes off. If you have enabled automatic activation, the data connection is established automatically.

Note The LED is **always off** after successful installation, even after reboot! The LED only comes on again if you restart installation.

Note If the LED is steady yellow after pointing, the installation failed. See *Troubleshooting* on page 78.

1. If you have a computer connected to the EXPLORER 540, you can follow the process in the web interface, see *To restart the installation process* on page 47.

6. The EXPLORER 540 is now ready for use. For details on how to access the EXPLORER 540 from a remote location, see *To access the terminal from a remote location* on page 20.

After successful installation, the EXPLORER 540 will automatically register on the BGAN network at every power-up and, if automatic activation is enabled, establish a data connection again. This is also the case following one of the “wake-on” actions after power save.

Audio assisted pointing

By default, the EXPLORER 540 uses a pointing sound to indicate the signal level during the pointing procedure (Audio assisted pointing). The sound pattern is as follows:

- Poor signal strength: • • • •
- Good signal strength: ●●●●●●●●●●●●●●●●●●
- Optimum signal strength: ████████████████████ (continuous sound instead of single “beeps”)

You can disable the pointing sound using the web interface. For details, see *To enable or disable the pointing sound* on page 52.

To repoint the antenna

You may need to point the antenna again later, e.g. if the terminal has been moved or the signal is blocked.

To start the installation process again, you can do one of the following:

- Use the web interface (⚙️ (Control panel) and then **Installation**). See *To restart the installation process* on page 47.
- Reset the EXPLORER 540 using the Reset button inside the interface enclosure on the back of the terminal. See *Reset button* on page 77.

Do you need a PIN?

Important | If your EXPLORER 540 is used in an unmanned M2M system, you will not be able to enter a PIN code. In this case we strongly recommend enabling **Auto SIM PIN validation** in the web interface before using the system. See below.

To avoid having to enter a PIN at startup, you have two options:

- Enable **Auto SIM PIN validation**. See *Auto SIM PIN validation* on page 64. With this option enabled, the EXPLORER 540 automatically sends the PIN to the SIM card at every startup. Note that if you later want change the SIM card, you should first disable Auto SIM PIN validation.
- Disable the use of a SIM PIN. See *To enable or disable the use of a SIM PIN* on page 64. When the SIM PIN is disabled, the SIM can be used by other terminals without a PIN.

If you are using a SIM PIN in your system, you can enter the SIM PIN from the built-in web interface. For details, see *To enter the SIM PIN* on page 74.

Note | If you are asked for a PIN in the web interface and you select **Cancel**, you cannot communicate on the network, but you can access all settings.

To access the web interface

You can use the built-in web interface for configuration and operation of the EXPLORER 540. To access the web interface, do as follows:

1. Start up the terminal.
2. Connect your computer to the LAN interface of the terminal. If the terminal is already installed in your system, you must connect via a router or switch, because there is only one LAN interface on the EXPLORER 540.
3. Open your browser and enter the IP address of the terminal in the address bar. The default IP address of the terminal is **192.168.0.1**.
4. Log in as user or administrator. Default user names and passwords are:
 - **user**: User name = **user**, password = <**serial number of the EXPLORER 540**>
 - **administrator**: User name = **administrator**, password = **admin**

Important

Remember to change the administrator password! See *To change the administrator password* on page 62.

If the terminal is not yet installed, it will automatically start the installation procedure and the web interface will show the progress. Otherwise the web interface will show the dashboard.

For more information on the web interface, see *The web interface* on page 39.

M2M application examples

When an M2M SIM card is installed, the EXPLORER 540 uses the BGAN M2M service (see *BGAN M2M services* on page 5).

If a PoE switch is not included in the connected M2M equipment, you must provide power either through the LAN interface with a PoE injector or a PoE switch connected, or from a battery connected to the DC input. The following sections show examples.

PoE injector

The picture below shows an example of an M2M application using a PoE injector to provide the power to the EXPLORER 540 through the LAN interface. Note that the PoE injector must comply with the requirements for **PoE+ IEEE 802.3at type 2 class 4**. The PoE injector is connected to a power supply and “adds” power to the LAN connection for the EXPLORER 540. For specifications and pinout for the LAN interface on the EXPLORER 540, see *LAN interface (X1 or X2)* on page 90.

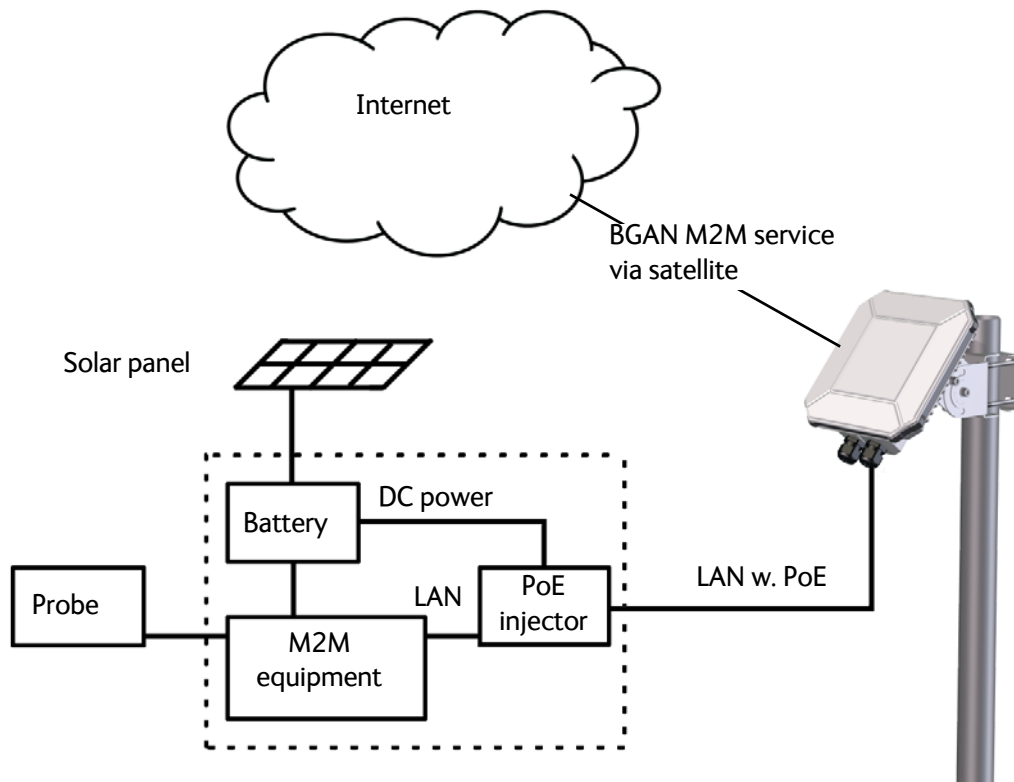

Separate battery supply

Another example is the scenario below, where power is supplied from a separate battery connected to the DC input of the EXPLORER 540. This solution may be used e.g. if you want to limit the power consumption, or if a PoE source is not available. For specifications and pinout for the DC input on the EXPLORER 540, see *DC power input (X4)* on page 91.

For installation instructions, see the supplied EXPLORER 540 Installation guide. Note that you must use a fused or current-limiting DC power supply (battery).

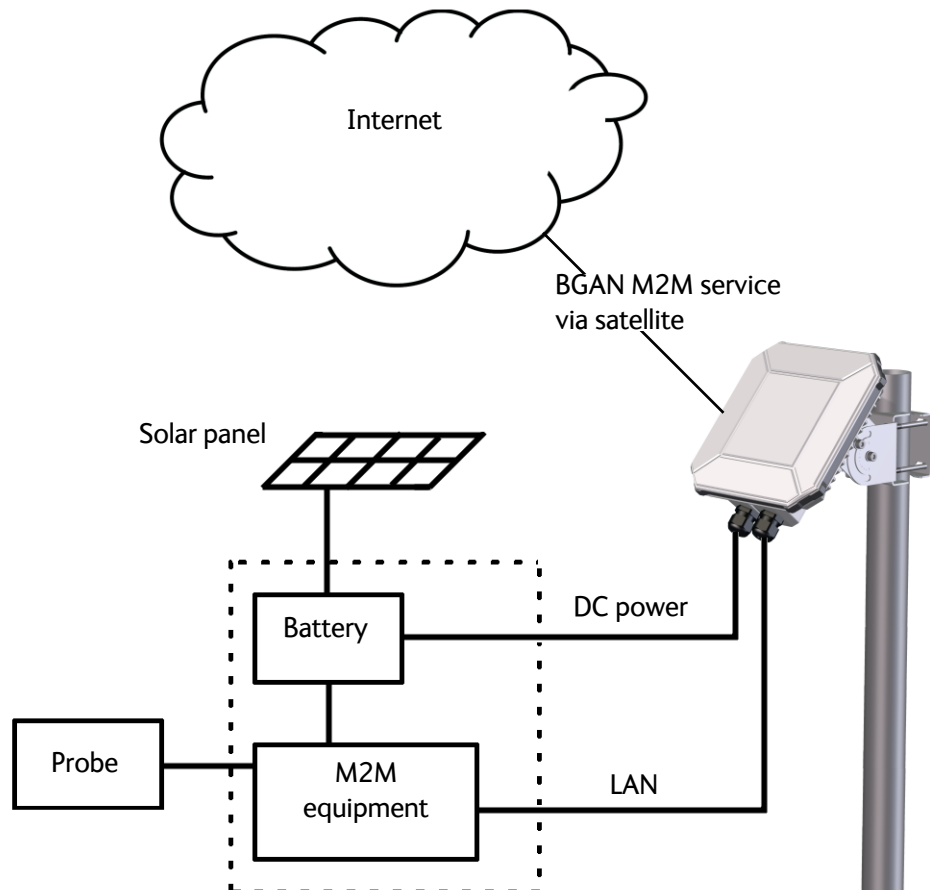

I/O pins

The EXPLORER 540 has 3 I/O pins, two assigned pins and 1 general purpose pin.

- Request wake up (input)
- Terminal ready (output)
- Control/Status input/output

The Control/Status input/output can be configured (input/output and high/low) using the web interface, and with AT commands you can control or read the status of the pin. For details on the I/O pins, see *I/O pins (Settings)* on page 72 and *I/O connector (X5)* on page 91.

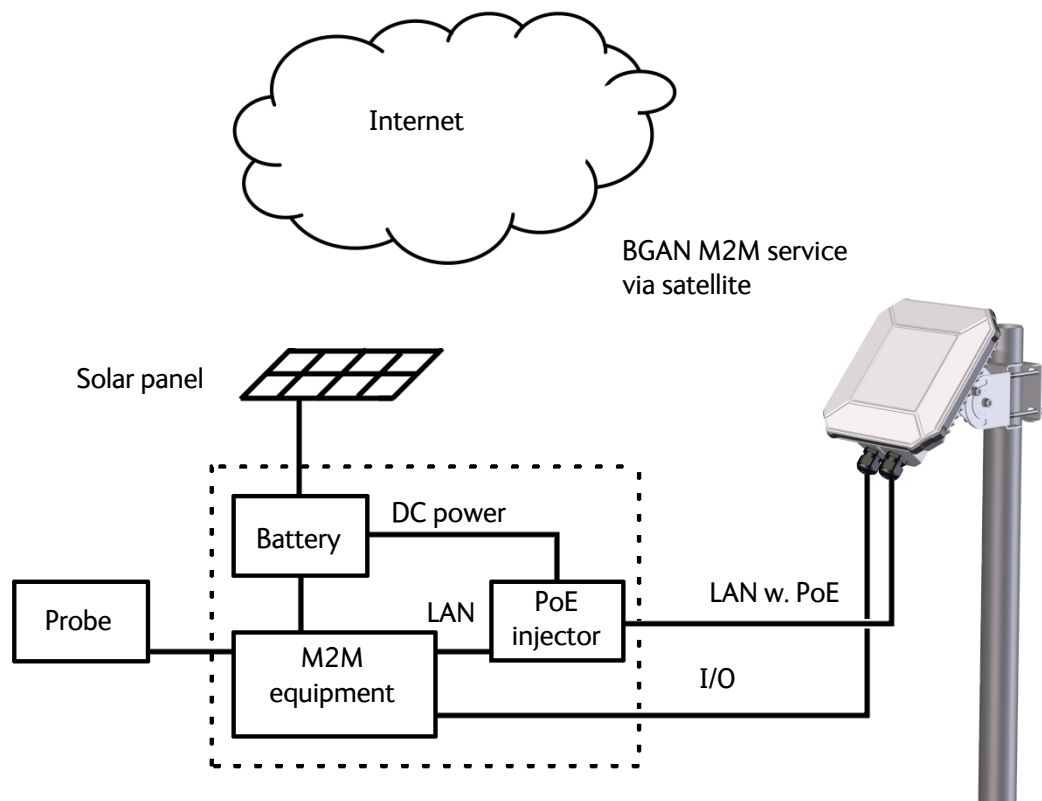

Operation

This chapter describes operation and basic setup, primarily for M2M use.

For information on **configuration** with the web interface, see *Configuration with web interface* on page 38.

This chapter describes:

- *Local or remote control*
- *To access the terminal using AT commands*
- *To access the terminal from a remote location*
- *Security setup*
- *To control data connections (PDP contexts)*
- *Power-saving*
- *Remote software upgrade*
- *File transfer*
- *Status of the EXPLORER 540*

For information on functions that are **not** available with an M2M subscription but only with a standard BGAN subscription, see *BGAN non-M2M functions* on page 108.

Local or remote control

The EXPLORER 540 can be controlled both locally using the LAN interface and from a remote location over the BGAN network. For M2M operation, remote control is essential, since the EXPLORER 540 is most likely installed in a remote location where local human access is rare and maybe difficult.

Note that different levels of access control apply to different means of access. See *Security setup* on page 27.

You have the following options:

Local control:

- **web interface:** Connect a computer to the LAN interface and use a browser to access the built-in web interface. See *Configuration with web interface* on page 38.
- **AT-commands:** Connect a computer to the LAN interface and use a terminal program to send commands to the EXPLORER 540 or connect other equipment capable of issuing AT commands to the EXPLORER 540 (e.g. in an M2M application). See *To access the terminal using AT commands* on page 19.

Remote control:

- SMS commands: You can use SMS commands e.g. to start and stop your data connection and send and receive AT commands to and from the terminal. See *Remote access with SMS* on page 20.
- AT commands: When a data connection is established you can control the EXPLORER 540 with AT commands over the BGAN satellite network. See *To access the terminal from a remote location* on page 20 and *To access the terminal using AT commands* on page 19.
- web interface: When a data connection is established you can control the EXPLORER 540 over the BGAN satellite network by accessing the built-in web interface. See *Remote access to the web interface* on page 25.
- The distributors may have their own Graphical User Interface, which could be built on e.g. Inmarsat's M2M API or similar. Contact your distributor for information.

To access the terminal using AT commands

Important

Before putting the EXPLORER 540 into operation, remember to set up the security features in order to avoid unintended use. See *Security setup* on page 27.

The EXPLORER 540 supports a number of M2M specific AT commands as well as a set of general AT commands. For a list of the most common commands, see *AT commands* on page 99.

AT commands can also be encapsulated in an SMS sent to (and from) the terminal's phone number. See *Remote access with SMS* on page 20.

1. Connect your computer (or M2M equipment) to the EXPLORER 540 terminal.
You may connect locally to the terminal or use a remote connection.
2. On the connected computer, start a Telnet session.
3. Select TCP/IP and type in the IP address and port number.
 - For **local connection**, use the local IP address of the EXPLORER 540 (default 192.168.0.1) and port number 5454.
 - For **remote connection**, use the external IP address¹ of the terminal. The port number for AT commands is normally 5454 but can be changed in the web interface **Remote management** page under **AT commands** (see *Remote management* on page 68).

-
1. The external IP address is found in one of the following ways:
 1. If you are using SMS activation, you will receive an SMS with the IP address.
See *ACTIVATE: Activate a data connection with an SMS* on page 21
 2. Otherwise, you can use the GETINFO (ALL) command to obtain the external IP address, if you already have a session running.
This is the IP address you must use to access the terminal.
Note: If Static IP is included in your airtime subscription, we recommend using this static public IP address for the terminal in order to provide easy access to the terminal. To use the static IP address, you must set the APN source to SIM default. For details, see *To change the APN for a connection package* on page 43.

- When the connection is established, type in your AT commands. Note that you have to enter the administrator password with the AT_ICLCK command. See *Security setup* on page 27.

To access the terminal from a remote location

Remote access with SMS

Important

By default, any phone number can access the EXPLORER 540 with an SMS, if they have the phone number of the terminal and the remote SMS password. Before installing the EXPLORER 540 you should set up the security measures for the terminal. See *Security setup* on page 27 and *To set up remote access with SMS* on page 69.

You can perform a number of actions and some configuration on the EXPLORER 540 using SMS commands.

Send an SMS to the mobile number of the terminal. The text in the SMS must start with the SMS command and follow the syntax for the SMS commands. Note that the remote SMS password (default: **remote**) must be included with every command.

For an explanation of syntax and parameters, see *SMS remote commands* on page 95. Note that the remote SMS function is password protected.

The following SMS commands are supported.

SMS command	Function
ACTIVATE	Activates data connections for the device(s) connected to the EXPLORER 540
DEACTIVATE	Deactivates some or all the data connections for devices connected to the EXPLORER 540
CLEAR	Deletes SMS messages in the EXPLORER 540
GETINFO	Retrieves current information from the EXPLORER 540 such as call time, data usage, GPS position and global IP address.
RESTART	Restarts the EXPLORER 540
WATCHDOG	Requests or allows you to modify the current Watchdog settings (called Link monitoring in the EXPLORER 540)
ATCO	Allows you to send M2M related AT commands to the EXPLORER 540 which returns the response in an SMS
ADPWRST	Resets the EXPLORER 540 admin password to admin

The next sections show examples of each SMS command.



The following examples use the default remote SMS password, which is **remote**. the password may be different in your EXPLORER 540.

ACTIVATE: Activate a data connection with an SMS

The text in the activation SMS must have the following format for activating a connection:

```
ACTIVATE 1 {DHCP|STATIC|<name>|<IP addr>|ANY} {NA|<apn>}
{NA|<apn_user>} {NA|<apn_pwd>} <rsms_pwd>
```

Example: To activate one or more connections for remote management for connected equipment with IP address(es) assigned by DHCP, using default settings (NA) for APN, APN user name and APN password, send an SMS to the terminal with the text:
ACTIVATE 1 DHCP NA NA NA remote

Response:

You receive a response with the IP address you must use to access the terminal from a remote location.

Example: A confirmation SMS after sending an activation SMS may look like this:

```
IP: 161.30.181.31 (192.168.128.104)
SMS-Free: 88/100
WARNING: Ensure SMS-free > 5. Cleanup old msgs for
orderly remote-SMS-control
```

The first IP address is the global IP address assigned to the PDP context by the network, and the second IP address (in parenthesis) is the IP address (or host name, if the device was identified by host name) of the device connected on the local LAN, for which the PDP context was created.

DEACTIVATE: Deactivate a data connection

The text in the deactivation SMS must have the following format for deactivating a connection:

```
DEACTIVATE 1 {DHCP|STATIC|AWO|<name>|<IP addr>|ANY} <rsms_pwd>
```

Example: To deactivate connections for all DHCP IP addresses, send an SMS to the terminal with the text: **DEACTIVATE 1 DHCP remote**

Response:

You receive a response showing the IP address(es) for which the connection was deactivated.

Example: A confirmation SMS after sending a deactivation SMS may look like this:

```
LOCAL IP 192.168.128.104 DEACTIVATED
SMS-Free: 77/100
WARNING: Ensure SMS-free > 5. Cleanup old msgs for
orderly remote-SMS-control
```

CLEAR: Delete SMS messages in the EXPLORER 540

The text in the CLEAR SMS must have the following format:

```
CLEAR <category> SMS <rsms_pwd>
```

Example: To delete all SMS messages from the EXPLORER 540, send an SMS to the terminal with the text: **CLEAR 4 SMS remote**

Response:

No response is sent for this command.

GETINFO: Retrieve information from the EXPLORER 540

The text in the GETINFO SMS must have the following format:

```
GETINFO <info_mode> {GPS|ALL|USAGE} <rsms_pwd>
```

Example: To request all information with titles, send an SMS with the text:

```
GETINFO 1 ALL remote
```

Response: The response depends on the requested format (GPS/ALL/USAGE) and info mode. For the command in the example, the response would have the titles shown below.

```
Example: IMSI: 901112112456789  
IMEI: 35393803001003  
LAT: 32.89495  
LON: -117.20205  
SW: 1.0  
C/N0: 66  
Beam: 84  
Uptime: 59483  
GIP: 161.30.23.43
```

The Uptime is in seconds, and GIP is the global IP address of the first active PDP context.

RESTART: Restart the EXPLORER 540

The text in the RESTART SMS must have the following format:

```
RESTART 1 BGAN <rsms_pwd>
```

Example: To restart the EXPLORER 540, send an SMS with the text:

```
RESTART 1 BGAN remote
```

Response:

No response is sent for this command.

WATCHDOG: Request or modify watchdog settings

The text in the WATCHDOG SMS must have the following format:

```
WATCHDOG <wdog_op> <ping1> <ping2> <ping3> <ping_always> <ping_interval> <wdog_
enable> <rsms_pwd>
```

Example: WATCHDOG 2 100.100.100.130 100.100.100.110 200.247.237.254 0 20 1
remote

In this example, Link monitoring is set up as follows:

2: Set watchdog parameters
100.100.100.130: Primary IP address
100.100.100.110: Secondary IP address
200.247.237.254: Tertiary IP address
0: Send ping only if no IP data traffic
20: Ping interval (number of minutes between pings)
1: Enable watchdog
remote: Remote SMS password

Response:

You do not get an OK response. You can use the **WATCHDOG 1** command to get the status of the WATCHDOG feature.

See also *Link monitoring (watchdog)* on page 29.

ADPWRST: Reset the administrator password

To reset the administrator password you need the IMEI number of your terminal. If you can access the web interface, you can find the IMEI number under **Support > Extended status**, see *To view extended status* on page 60.

The text in the ADPWRST SMS must have the following format:

```
ADPWRST 1 <imei> <rsms_pwd>
```

Example: To reset the administrator password of a terminal with the IMEI number 363833-09-012345, send an SMS with the text:

```
ADPWRST 1 36383309012345 remote
```

Response:

You receive a response with the result of the action.

Example: A response for a successful ADPWRST command, could be:

```
ADMIN RESET SUCCESS
SMS-Free: 88/100
WARNING: Ensure SMS-free > 5. Cleanup old msgs for
orderly Remote SMS Control
```

ATCO: Send AT commands to the EXPLORER 540

The text in the ATCO SMS must have the following format:

```
ATCO <resp_mode> <rsms_pwd> <at_cmd>
```

Example: To command the EXPLORER 540 to download new software from the default FTP server via the default APN and upgrade to the new version immediately, send an SMS with the text:

```
ATCO 2 remote _IGETFW=1
```

Response:

You receive a response with the result of the action. In this example we have chosen to see only the final response (<resp_mode> = 2) and we have chosen immediate upgrade (<mode> = 1), so the final (and only) response will be related to the upgrade of the EXPLORER 540.

Example: For a successful completion of the command in the above example, the response would then be: `_IUPDFW: 0, Complete`

See also *ATCO response codes* on page 102.

List of supported ATCO commands:

The following AT commands are supported using the ATCO command in an SMS. For syntax and parameters, see *ATCO commands* on page 100.

- **_IGETFW** Get new firmware (and optionally install it)
See *Remote software upgrade* on page 33
- **_IUPDFW** Update the terminal with new firmware
See *Remote software upgrade* on page 33
- **_ISENDFILE** Send a file from the terminal to an FTP server
See *File transfer* on page 34
- **_IGETFILE** Retrieve a file from an FTP server to the terminal
See *File transfer* on page 34
- **_IUPDCFG** Update to a new configuration file
See *File transfer* on page 34
- **_IREMWEB** Open a connection for remote access to the terminal's Web interface
See *Remote access to the web interface* on page 25
- **_ICPWD** Change the terminal's admin password
See *Security setup* on page 27
- **_IATCROBST** Configure 3GGP LTE robustness feature

Remote access with AT commands

Access the terminal as described in *To access the terminal using AT commands* on page 19. You must use the external IP address of the EXPLORER 540.

Remote access to the web interface

Note When using remote access, the web interface may take a long time to load the pages, because the Internet connection may be slow.

There are two methods of getting remote access to the web interface:

- Using the AT command `_IREMWEB`, e.g. sent in an SMS (ATCO command)
- Using an EXPLORER 540 that is pre-configured with trusted IP addresses

The following sections describe these two methods.

Note Only one PDP context at a time can be used for remote web interface access.

To use AT commands to get remote access to the web interface

You can send the AT commands encapsulated in an SMS (ATCO commands). For details, see *Remote access with SMS* on page 20.

Note If remote SMS command access has been disabled, you can enable it either using the web interface or using AT commands. See *To set up remote access with SMS* on page 69 and *To set up the security with AT commands* on page 27 (step 4.).

Relevant commands:

`_IREMWEB`

See *ATCO commands* on page 100 for syntax and parameters.

1. To use an SMS to allow access to the web interface for specific IP addresses, send the following command:

```
ATCO <resp_mode> <rsms_pwd> _IREMWEB=1,<ip address>[,<ip address>]
```

Example: `ATCO 2 remote _IREMWEB=1, 214.123.189.119`

In this example the command specifies no immediate response, only when the global IP address is sent along (2). The remote SMS password is **remote** and the IP address 214.123.189.119 can get remote access to the web interface (if two IP addresses are listed, it is interpreted as a range of IP addresses).

2. The EXPLORER 540 should now return an SMS response with the external IP address of the terminal.

Example: `_IREMWEB:81, GlobalIP:161.30.181.31`

81 is the response code for a remote web connection that was set up successfully. It is followed by the global IP address, which is the IP address to enter in your browser to access the web interface from the remote device with the IP address you specified in the command.

3. On the remote computer, open your web browser.
4. In the address bar of your browser, enter the global IP address of the EXPLORER 540 (received in the response above).

You should now be connected to the built-in web interface of the terminal.

Note Access to the EXPLORER 540 web interface is restricted with a password. See *Security setup* on page 27 and *Passwords* on page 62.

To get remote access to the web interface from a trusted IP address (preconfigured)

Note This method requires that you initially have local access to the EXPLORER 540. If not, use the **_IREMWEB** command described in the previous section.

1. Connect a computer to the EXPLORER 540 and access the web interface locally.
2. Prepare the terminal as described in *Remote management* on page 68.
3. Make sure your remote computer has access to the Internet.
4. On the remote computer, open your web browser.
5. In the address bar of your browser, enter the IP address of the terminal followed by a colon and the port number
http://<ip address>:<incoming port>
 - <ip address> is the external IP address of the EXPLORER 540. The external IP address can only be obtained when a data connection (PDP context) is established. If a data connection is started, you can get the external IP address with the GETINFO SMS command, see *GETINFO: Retrieve information from the EXPLORER 540* on page 22.
 - <incoming port> is the port you defined in *Remote management* on page 68 (Incoming port for web application, default port 80).

Example: If the IP address of the terminal is 161.30.180.12 and the incoming port number defined in the Remote management page in the web interface is 80, enter **http://161.30.180.12:80**.

You should now be connected to the built-in web interface of the terminal.

Note Access to the EXPLORER 540 web interface is restricted with a password. See *Security setup* on page 27 and *Passwords* on page 62.

Security setup

Important

By default any phone number can access the EXPLORER 540 with an SMS! To protect against unauthorized access, change the remote SMS password and make a list of trusted phone numbers. See *To set up remote access with SMS* on page 69 and *To set up the security with AT commands* below.

Overview of security measures

Since the EXPLORER 540 is most likely placed in remote areas without direct supervision, it is important to protect it against unauthorized access.

The EXPLORER 540 has the following security measures:

- User and administrator passwords for the web interface.
- Admin password for AT shell and SMS control.
- White list for SMS control (list of trusted phone numbers).
- MAC filtering
- SIM personalization.
Optional SIM lock (lock to provider) and optional PIN lock (lock to EXPLORER 540 terminal).
- Disable Reset button.
One of the functions of the Reset button is to reset to factory default, which also resets the administrator password. This function can be disabled using the web interface.

You can set up these security measures in the web interface or with AT commands. see the next sections for details.

To set up the security with AT commands

For details on how to send AT commands to the EXPLORER 540, see *To access the terminal using AT commands* on page 19.

For details on syntax and parameters for the AT commands, see *AT commands* on page 99.

Do as follows:

1. Disable administration lock:
AT_ICLCK=AD,0,<password>

Example: AT_ICLCK=AD,0,admin

When you get an OK reply you have administrator access to the AT shell.

2. Set new administrator password:
AT_ICPWD=AD,<old password>,<new password>

Example: AT_ICPWD=AD,admin,myadmpwd

When you get an OK reply the administrator password is set to the new password (myadmpwd in the example).

- Set new password for remote SMS:
AT_ICPWD=RS,<old password>,<new password>

Note | The password cannot contain spaces, e.g. “new pw” is not accepted, whereas “new_pw” is accepted.

Example: AT_ICPWD=RS,remote,mysmpwd

When you get an OK reply the password for remote SMS access is set to the new password (mysmpwd in the example).

- Disable/enable remote SMS commands:
Disable: AT_ISMSRMT=0
Enable: AT_ISMSRMT=1

Important | If you disable remote SMS commands there is no way to access the terminal remotely, unless you have an open data connection (PDP context)! Instead we recommend to define a set of trusted phone numbers, see *To set up remote access with SMS* on page 69.

- Specify a white list of trusted MAC addresses:

Note | Until MAC address filtering is enabled, all MAC addresses are allowed and the white list has no effect.

AT_IMACLOCAD=1,0,<MAC address>[,<MAC address> (etc.)]

Example: AT_IMACLOCAD=1,0,00:B5:E0:76:FD:C2,00:B5:A0:84:F9:E2

When you get an OK reply, the specified MAC addresses are added to the white list.

Important | Remember to add the MAC address of your own device. Enabling the MAC address locking without adding your own device MAC address will block for any local access to the Terminal!

- Turn on MAC address filtering:
AT_IMACLOC=1,0
When you get an OK reply, MAC address filtering is enabled for Ethernet, and only the MAC addresses specified in the white list can get access (previous step).
- Enable administration lock:
AT_ICLCK=AD,1,<password>

Example: AT_ICLCK=AD,1,myadmpwd

When you get an OK reply, the system is protected with the administrator password.

To set up the security with the web interface

If you want to setup the security with the web interface, see the following sections:

- User and administrator passwords for web interface: *Passwords* on page 62
- Admin password for AT shell (same as for web interface): *Passwords* on page 62
- Password for remote SMS access: *To set up remote access with SMS* on page 69

- Trusted phone numbers for SMS control: *To set up remote access with SMS* on page 69
- MAC filtering: *To manage connected devices (Traffic control)* on page 54
- SIM personalization: *Auto SIM PIN validation* on page 64 and *SIM lock* on page 65
- Disable Reset button: *Reset button* on page 73.

To control data connections (PDP contexts)

Automatic Context Activation (ACA)

In the web interface you can set up the EXPLORER 540 to automatically establish a data connection when it is registered on the satellite network. See *To set up the connection mode* step 3. on page 51. In the web interface ACA is called “Automatic activation”. Automatic activation also applies to the “wake-on” actions after power save mode (see *Power-saving* on page 31) and by recovery after e.g. loss of power.

Link monitoring (watchdog)

It is strongly recommended to use link monitoring to monitor your locally established IP connection, as it enables you to test the BGAN connectivity and to keep your PDP context alive.

With this feature activated, the terminal will send out ping commands to up to three servers of your choice. When a data session is started, the terminal will start sending ping commands to the Primary IP address the number of times specified. If no response is received, it will send the same number of ping commands to the Secondary and then Tertiary IP address, if available. If no response is received from any of the IP addresses, the terminal will eventually restart.

For configuration with the web interface, see *Link monitoring* on page 66.

For configuration with SMS command, see *WATCHDOG: Request or modify watchdog settings* on page 23.

Note | Link monitoring only applies when the data connection is started locally by equipment connected to the EXPLORER 540. Data connections started with the SMS command **ACTIVATE** cannot be monitored with link monitoring.

Manual activation of data connections

You can manually activate a data connection in the following ways:

- Remote: Send an SMS to the EXPLORER 540. See *ACTIVATE: Activate a data connection with an SMS* on page 21.
- Local (EXPLORER 540 LAN interface):
 - Access the web interface locally and click the tile for the data connection on the dashboard. See *To start and stop data connections* on page 42 or
 - Send an AT command to the terminal. See *To configure the connected equipment for PPPoE* on page 30 (the example), *To access the terminal using AT commands* on page 19 and *Context management AT commands* on page 105.

PPPoE (Point-to-Point Protocol over Ethernet)

To configure the connected equipment for PPPoE

How to configure your equipment depends on the type of equipment. Refer to the user documentation of the equipment. As a minimum, you need to configure the **user name and password** in your equipment in order to make PPPoE work with the terminal

The user name and password can be left blank (or insert user name: void and password: void). Then the registration on the Access Point is most commonly done in such a way that the data connection is established with a dynamic IP address from the airtime provider.

To request a static IP (if subscribed to) from the Access Point you must type in the user name and password from your airtime subscription.

Note for MAC OS: User name and password are required. For some ISPs you can use user name void and password void. Contact your airtime provider for further information.

To send commands with PPPoE

You can use the command **XBB:<AT String>** to send AT commands over PPPoE.

Example: To start a Standard data connection with the Context identifier "1", type
`XBB:AT+CGDCONT=1,ip,bgan.inmarsat.com;+CGEQREQ=1,3`

Note that there are two commands involved, +CGDCONT and +CGEQREQ.

+CGDCONT defines the context ID (1), the connection type (IP) and the APN (bgan.inmarsat.com).

+CGEQREQ starts a data connection for the defined context ID (1) using traffic class Standard data (3)

Note that because the traffic class is 3 (Standard data), the remaining parameters (max. and guaranteed bit rates etc.) are omitted. See also *Context management AT commands* on page 105.

Power-saving

There are two methods to save power in the EXPLORER 540.

- Sleep mode
- Power save mode

Sleep mode

When in sleep mode the terminal is registered, attached and capable of exchanging data between the LAN and the BGAN satellite interface.

The system enters sleep mode whenever possible, i.e. if it is not active and not in power save mode.

Power save mode

In Power save mode, the terminal deregisters and gracefully closes down the terminal to save power.

Note

The following conditions will prevent the terminal from entering Power save mode:

- The web interface is open
- Data/SMS traffic
- Software update ongoing
- Incoming/outgoing calls
- Wake up input pin (GPI-1) active

To use the Power save mode you must configure one or more “wake up” methods:

- Wake up on daily basis
- Wake up on input pin (dedicated I/O pin)

General power save settings:

- Set the number of minutes without any activity (Idle time) before the terminal enters power save mode
- Set whether or not the power save function should be prevented when a satellite connection (PDP context) is open (only configurable with web interface)

You can also configure the wake up methods and the general power save settings in the web interface. See *Power save (Settings)* on page 71.

To set the idle time before power save

If you are using Power save mode and none of the conditions that prevent Power save mode are present (mentioned in the note above), the system will go into Power save mode after a defined idle time.

Note

If the Idle time is set to “0”, the Power save function is disabled!

For configuration with AT commands, use the AT command `_IPWSAVSCHED` as follows:

1. Set the idle time before power save:
`AT_IPWSAVSCHED=<psmode>,<psvalue>`

Example: `AT_IPWSAVSCHED=IDLE_TRG,15`

In this example, the power save mode is idle time (IDLE_TRIG), and the idle time before the terminal enters power save mode is 15 minutes.

Important Remember to configure minimum one of the wake up functions described below - otherwise the EXPLORER 540 will not be able to enter power save mode.

For configuration with the web interface, see *Power save (Settings)* on page 71.

Wake up on daily basis

Daily wake up is a method to save power by setting a timer to regularly wake up the terminal. When this is used in combination with the output pin that reflects whether the terminal is awake, it allows for power efficient regular operation of M2M equipment, e.g. for transmission of environmental probe measurements. For information on the “Terminal ready” output pin see *I/O connector (X5)* on page 91.

To configure wake up on daily basis

Note If the wake-up time of day is set to “0”, the “Wake up time of day” function is disabled!

For configuration with AT commands, use the AT command `_IPWSAVSCHED` as follows:

1. Set the time of day that the terminal must wake up from power save:
`AT_IPWSAVSCHED=<psmode>,<psvalue>`

Example: `AT_IPWSAVSCHED=TOD_TRG,24:00`

In the example above, the power save mode is the Time Of Day (TOD), and the time of day to wake up from power save is 24:00.

For configuration with the web interface, see *Power save (Settings)* on page 71.

Wake up on input pin (GPI)

The **Request wake up** pin (pin 1, input) allows the M2M equipment to signal to the terminal whether it should wake up (active) or attempt to go into power save mode.

In the web interface you can:

- Enable/disable the input pin
- select the polarity of the input pin (Active high/low).

See *Power save (Settings)* on page 71 and *I/O connector (X5)* on page 91.

Remote software upgrade

User initiated software upgrade

You can initiate a remote software upgrade with an AT command, either from the command interface or encapsulated in an SMS (ATCO command).

_IGETFW tells the terminal to get software from an FTP server and either upgrade the terminal software or download the software file to the terminal for later upgrade.

Note | FTP server: With M2M subscription you can use Inmarsat's M2M FUP server (default FTP server for software upgrade). This is not available for Non-M2M subscriptions.

_IUPDFW tells the terminal to upgrade its software to the downloaded file.

For Syntax and parameters, see *ATCO commands* on page 100.

To upgrade the software

If you have an M2M subscription, the EXPLORER 540 should be available from the Inmarsat FTP server. If not, download the new software¹ or acquire the software from Cobham SATCOM and place it on your FTP server.

- To access the EXPLORER 540, use one of the following:
 - a computer connected to the Internet, see *Remote access with AT commands* on page 24, or
 - equipment connected to a cellular network, see *Remote access with SMS* on page 20.

Note that you need a password for both access methods. For AT commands, use the **AT_ICLCK** command with the admin password, for SMS, use the remote SMS password.

- Use the command **_IGETFW** to initiate the software download (and maybe upgrade) from the specified FTP server. If you are using default APN and default FTP server these can be left out.

Example: AT_IGETFW=1

In this example, the terminal will get the software from the default FTP server via the default APN and download and then upgrade the software in the terminal.

Note | The Inmarsat FTP server for firmware upgrade is only available with M2M subscription. If you have a non-M2M subscription you must specify a third party FTP server for the software upgrade.

- The terminal prepares for software update, connects to the specified FTP server and downloads the software image.
If you have selected **Deferred update** (**_IGETFW=0**), you have to use the command **_IUPDFW** followed by the file name when you want the terminal to upgrade the software.

- You can download the software from the "Self Service Centre" at www.cobham.com/satcom, select **Service and Support > Cobham SATCOM Service and Support** and then **24-7 Self Service Centre / Technical Downloads**. Locate the EXPLORER 540 software.

4. If you have selected **Immediate update** (_IGETFW=1), the terminal updates the system, reboots, installs the update and verifies the online connection.
5. When the software upgrade is successfully completed you get an AT or SMS command response with the message **Complete**.

Example: _IUPDFW: 0, Complete

For configuration with the web interface, see *To update software* on page 60.

File transfer

Using AT commands, you can transfer a configuration file or a log file between the EXPLORER 540 (local directory in EXPLORER 540 is "/") and an FTP server over the satellite network.

_IGETFILE tells the terminal to get a file from an FTP server (e.g. a configuration file)

_ISENDFILE tells the terminal to send a file to an FTP server (e.g. a log file)

_IUPDCFG tells the terminal to update the EXPLORER 540 configuration with the contents of the previously downloaded configuration file.

For Syntax and parameters, see *ATCO commands* on page 100.

Configuration file

If you need to reuse a configuration in other terminals of the same type, you can save your current configuration to a file, which can then be loaded into the other terminal(s).

Note

Be aware that if the terminals have different software versions, some of the settings may be different than expected. If possible, use the same software version in the terminals.

Save configuration

To command the EXPLORER 540 to save its configuration to a file and transfer it to an FTP server, do as follows:

1. To access the EXPLORER 540, use one of the following:
 - a computer connected to the Internet, see *Remote access with AT commands* on page 24, or
 - equipment connected to a cellular network, see *Remote access with SMS* on page 20.

Note that you need a password for both access methods. For AT commands, use the AT_ICLCK command with the admin password, for SMS, use the remote SMS password.
2. Send the command **_ISENDFILE** to the EXPLORER 540 to make it send the configuration file to the specified destination on your FTP server.

Example: AT_ISENDFILE="/", "config.txt", "ftpdirectory", "ftp.my
ftpserver.com", "ftp-username", "ftp-password"

In this example, the terminal will look for a file named **config.txt** in the local directory (*/*) in the terminal, and send the file to the directory **ftpdirectory** on the FTP server named **ftp.myftpserver.com**. The user name **ftp-username** and password **ftp-password** give access to the FTP server. The default APN is used (APN info is left out).

3. You get a response command that the file was transferred successfully.

Example: `_ISENDFILE: 0, Complete`

Load configuration

To command the EXPLORER 540 to update its configuration, do as follows:

1. Place the configuration file on your FTP server.
2. To access the EXPLORER 540, use one of the following:
 - a computer connected to the Internet, see *Remote access with AT commands* on page 24, or
 - equipment connected to a cellular network, see *Remote access with SMS* on page 20.

Note that you need a password for both access methods. For AT commands, use the `AT_ICLCK` command with the admin password, for SMS, use the remote SMS password.

3. Send the command **_IGETFILE** to the EXPLORER 540 to download the configuration file from the specified FTP server.
Leave out APN information if you are using default APN.

Example: `AT_IGETFILE="ftpdirectory","config.txt","/","ftp.myftpserver.com",
"ftp-username","ftp-password"`

In this example, the terminal will look for a file named **config.txt** in the directory **ftpdirectory** on the FTP server named **ftp.myftpserver.com** and download the file to the directory named */* in the terminal. The user name **ftp-username** and password **ftp-password** give access to the FTP server. The default APN is used (APN info is left out).

4. Use the command **AT_IUPDCFG** to upgrade the EXPLORER 540 configuration using the file downloaded in step 3.

Example: `AT_IUPDCFG=config.txt`

This command will take the downloaded configuration file named **config.txt** and use it to update the configuration of the EXPLORER 540.

Note | The terminal will reboot when the configuration is updated.

5. You get a response command that the configuration was successfully upgraded.

Example: `_IGETFILE: 0, Complete`

To save or load a configuration using the web interface, see *To save or load a configuration* on page 65.

Log file(s)

Using AT commands, you can command the EXPLORER 540 to send the following log files to an FTP server:

- Diagnostics report: **diagreport.tar.gz**. A report containing useful information for troubleshooting (includes the logs below as well as other information).
- Event log: **event.csv**. A log of events that are signalled to the user.
- System log: **syslog.log**. A log of internal events in the EXPLORER 540.
- AT command log: **at_log.txt**. A log of all AT commands sent and received by the EXPLORER 540.

To command the EXPLORER 540 to send a log file to an FTP server, do as follows:

1. To access the EXPLORER 540, use one of the following:
 - a computer connected to the Internet, see *Remote access with AT commands* on page 24, or
 - equipment connected to a cellular network, see *Remote access with SMS* on page 20.

Note that you need a password for both access methods. For AT commands, use the AT_ICLCK command with the admin password, for SMS, use the remote SMS password.
2. Send the command **_ISENDFILE** to the EXPLORER 540 to make it send a log file to the specified destination on your FTP server.

Example: `_ISENDFILE="/","syslog.log","ftpdirectory","ftp.myftpserver.com","ftp-username","ftp-password"`

In this example, the terminal will look for a file named **syslog.log** in the local directory `/` in the terminal, and send the file to the directory **ftpdirectory** on the FTP server named **ftp.myftpserver.com**. The user name **ftp-username** and password **ftp-password** give access to the FTP server. The APN is left out to indicate that the default APN is used.

3. You get a response command that the file was transferred successfully.

Example: `_ISENDFILE: 0, Complete`

Using the web interface you can see the Event log and create a diagnostics report. See *Log files* on page 86.

Status of the EXPLORER 540

There are basically three ways of getting status from the EXPLORER 540:

- Access the built-in web interface. The Status page shows information such as terminal status, network status, position status and ongoing communication. See *Status information* on page 45.
- Send the SMS command **GETINFO** to the EXPLORER 540. This command retrieves information from the EXPLORER 540 such as call time, data usage, GPS position and global IP address. For details, see *ATCO commands* on page 100

- I/O pin 2 (Terminal ready output). If you connect to this pin you can get information on whether or not the terminal is ready to communicate with connected equipment. See *Power save (Settings)* on page 71 and *I/O connector (X5)* on page 91.
- GPIO pin 3, see next section.

Additionally, until installation is completed you can use the LED to follow the status. See *Light indicator* on page 81.

Control or status with GPIO pin 3

The GPIO pin 3 is configurable in the web interface to be input or output, and active low or active high. You can use the AT command `_ITGPIO` to activate or deactivate the pin (if configured as output) or read the status of the pin (if configured as input).

For configuration, see *I/O pins (Settings)* on page 72.

For specifications, see *I/O connector (X5)* on page 91.

To read the status of GPIO pin 3 (input)

Do as follows:

1. Configure GPIO pin 3 in the web interface to be input.
2. Send the command `_ITGPIO?` to the terminal.
3. You get a response saying whether the pin is active or inactive (1 is active, 0 is inactive). Note that the setting in the web interface determines whether the pin is active high or low.

Example: `_ITGPIO: 1`
`OK`

To activate or deactivate GPIO pin 3 (output)

Do as follows:

1. Configure GPIO pin 3 in the web interface to be output.
2. Send the command `_ITGPIO=1` (activate) or `_ITGPIO=0` (deactivate) to the terminal.
3. You get an **OK** response when the pin is successfully activated or deactivated.

Configuration with web interface

This chapter describes how to use the **web interface** to operate, set up and configure your system. It has the following sections:

- *The web interface*
- *To control data connections from web interface*
- *Status information*
- *The Control panel*
- *To restart the installation process*
- *To use the logs*
- *To manage connected devices (Traffic control)*
- *Support features*
- *Terminal settings*
- *To set up your data connection packages (BGAN M2M)*
- *To set up tracking*
- *Advanced settings*
- *To enter the SIM PIN in the web interface*

The web interface

What is the web interface?

The web interface is built into the terminal and is used for operating, setting up and configuring the system.

You can access the web interface from a computer with a standard Internet browser.

To access and navigate the web interface

To access the web interface

To access the web interface, do as follows:

1. Start up the terminal.
2. Connect your computer to the terminal.
You can connect locally to the LAN interface or use a remote connection. See *Remote access to the web interface* on page 25.
3. Open your browser and enter the IP address of the terminal in the address bar.
For local connection, the default IP address of the terminal is **192.168.0.1**.
For remote connection, see *Remote access to the web interface* on page 25.
4. Enter user name and password. You can log in as user or as administrator.
 - Default for user: User id = user, Password = <serial number of the EXPLORER 540>
 - Default for admin: User id = administrator, Password = admin

Note | If the same user enters a wrong password 5 times in a row, he is locked out for 15 minutes (other users can still access the login page). After 15 minutes he can try again.

Note | Some parts of the web interface may not be accessible if the user permissions are limited. For information on how to set up user permissions, see *To set up user permissions* on page 63.

If the installation process is ongoing, the web interface will show a popup window with the progress of the installation process.

You can change the language to **French, German, Russian, Spanish, Chinese** or **Japanese**. See *To select the language* on page 52.

Overview of the web interface

When the web interface opens, the title bar shows the name of the product. The example below shows the Support page.

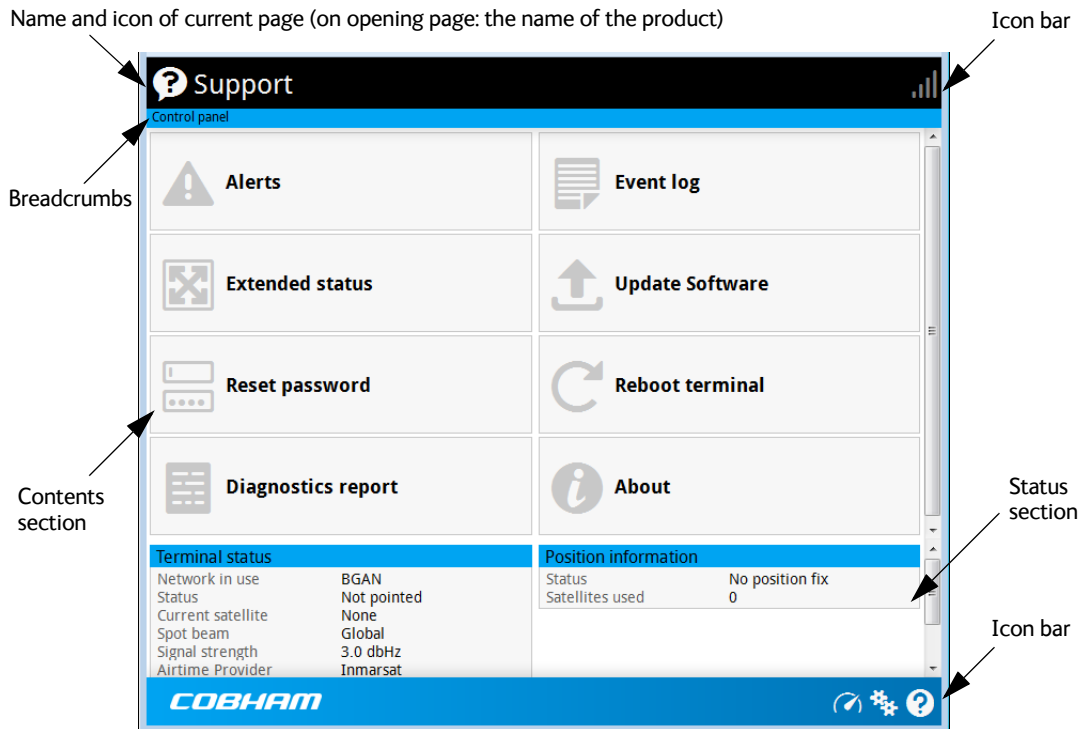







The web interface consists of the following sections.

- **Name** of current page. Tap or click to refresh the page.
- **Icon bars** at the top and bottom are present on all pages and hold icons that give access to status such as signal level as well as active alerts, when relevant. It also holds the icon for the Control panel. For explanations of the icons, see the next section, *Icons in the icon bars*.
- **Breadcrumbs** right below the icon bar show the current location in the menu system and gives access to the higher levels in the menu.
- **Contents section** shows the contents of the selected page. This section is used for viewing or changing settings, or for performing actions. On the opening page, this section is used to start and stop data connections.
- **Status section** shows the status of the terminal and the network connection, position information, ongoing calls and data sessions etc. The Status section is not shown on small screens. If the screen is small (e.g. on a smartphone), you can show/hide the status by clicking  at the bottom of the page.

Icons in the icon bars

The icon bars are always available at the top and bottom of the web interface. Some of the icons are permanent while others are temporary.

Icon	Explanation
	Signal level of the external network.
	Help. Click to get context-sensitive help for the current page.
	Control panel. Click to access the settings.
	Startup page where you can start and stop data connections. Click to go to the startup page.
	The "1" at the icon shows that a BGAN data connection package is running.
	Status. If the screen is not large enough to show the status field, this icon appears at the bottom of the page. Click the icon to see status of the terminal and satellite connection. Click again to exit the status page.
	An alert is active. Click the icon to see a list of active alerts. Note that this icon will remain in the icon bar as long as the alert is still active.

To navigate the web interface

- **To access status and settings**, tap or click the relevant icon in the icon bar or select  to access the **Control panel**. The status or settings are displayed in the contents section.
- **To see your current location and to move back through the Control Panel menu**, use the breadcrumbs just below the icon bar.
- **To scroll through longer pages**, use the scroll bar or swipe.
- **To refresh the current page**, press Ctrl+F5 (PC) or Apple+R (Apple) or Cmd+R (Apple).



To control data connections from web interface

The startup page of the web interface is used to start and stop data connections and to set up the data connections.

Note With a non-M2M subscription you have more options for the data connection. See Appendix C, *BGAN non-M2M functions*.

To start and stop data connections



By default, you must activate your data connection before you can access the Internet. However, you can enable automatic activation of a data connection. See step 3. on page 51.

Note The icons for starting  and stopping  connections are only active if the terminal is ready and registered on the BGAN network. Otherwise the text is greyed out and you cannot start data connections.

To start and stop data connections on your EXPLORER 540, do as follows:

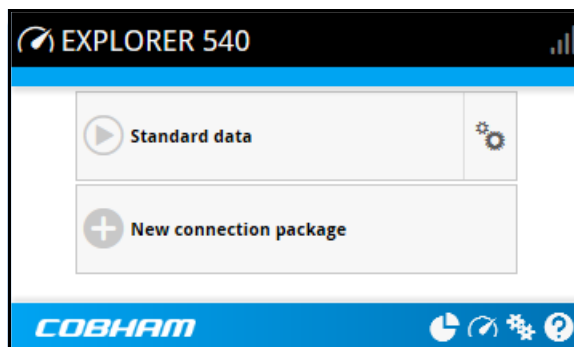
1. In the opening page, locate the connection package you want to start.



2. Click  to start the connection. The connections icon at the bottom of the page shows  when a BGAN data connection package is running.
3. Click  to stop the connection.

If the connection fails, the connection tile shows an exclamation mark  and an error message. The error message is also shown in the data log, see *Data log* on page 48.

When a connection is active, the icon changes to  and the tile for the active connection shows:

- IP address: The external IP address that has been assigned by the service provider to this session. If the connection was started by remote SMS, the local IP address is also shown.
- Transferred data: For Standard data, the tile shows the total amount of transmitted and received data since the connection was established.

To set up your data connection packages (BGAN M2M)

Note This section only describes the Standard data connection available with M2M subscriptions. For information on class 2 subscription, see *To set up data connections* on page 110.

Note You must be logged in as administrator to be able to change the settings for a data package.

To change the name of a connection package

To change the name of a connection package, click  in the right side of the tile with the connection package.

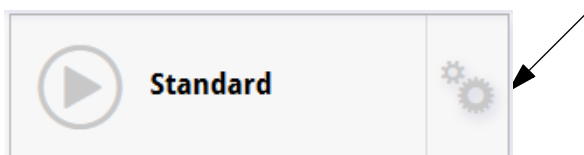

Click **Properties**, type in the new name and click **Save**. The new name is shown on the tile on the startup page.

To change the APN for a connection package

By default a connection package is set to use no IP Header compression and to use the APN (Access Point Name) from the SIM card. This is suitable for most applications.

Note It is recommended to leave **IP Header compression** disabled. This means that the data packets are transmitted more reliably with less data loss.

If you want to use a different APN, do as follows:

1. Click  in the right side of the tile with the connection package that you want to change.
2. Select **Parameters**.
3. Next to **APN**, select the source of the APN.
 - **SIM default** (default and recommended setting): The APN is taken from the SIM card.
 - **Network assigned**: The APN is assigned from the network.
 - **User defined**: APNs are provided from the Airtime Provider. Type in the APN next to **User defined name**.
4. If your APN uses a password, type in the **User name** and **Password** provided from the Airtime Provider.
5. Click **Save**.

To create a new connection package

Note You must be logged in as administrator to be able to create connection packages.

Do as follows:

1. Click **New connection package**.

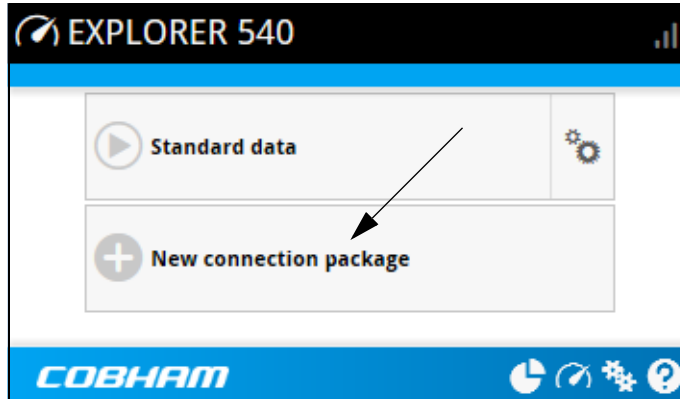

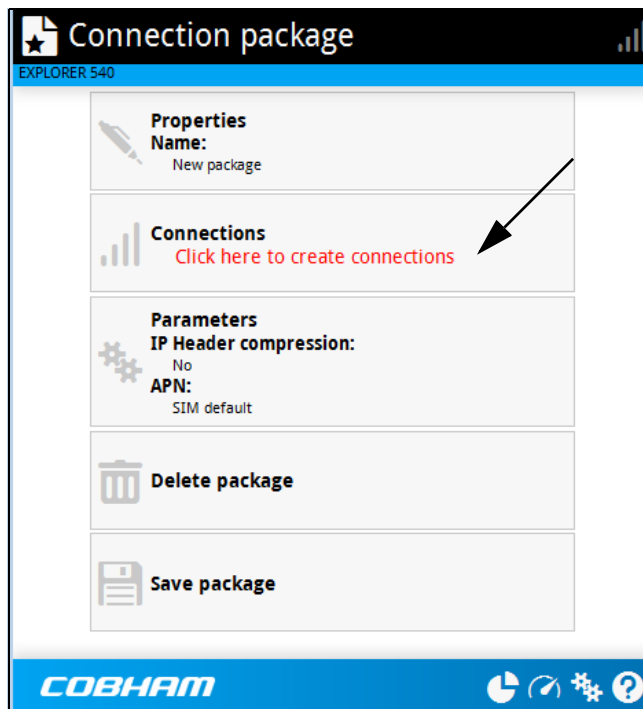

2. Type a name for the new package and click **Save**.
3. Click **Click here to create connections**.



4. Select the connection type you want for your new connection package. For M2M subscription, you can only select **Standard**.
5. Click **Save package**.

The new package should now appear as a new tile on the startup page. For details on **Parameters** (APN and IP Header compression) see *To change the APN for a connection package* on page 43.

Status information

If the window is large enough, it shows a status field at the bottom of the page or in the right side of the page. If not, click  at the bottom of the page to show the status page. Click  again to return to the previous page.

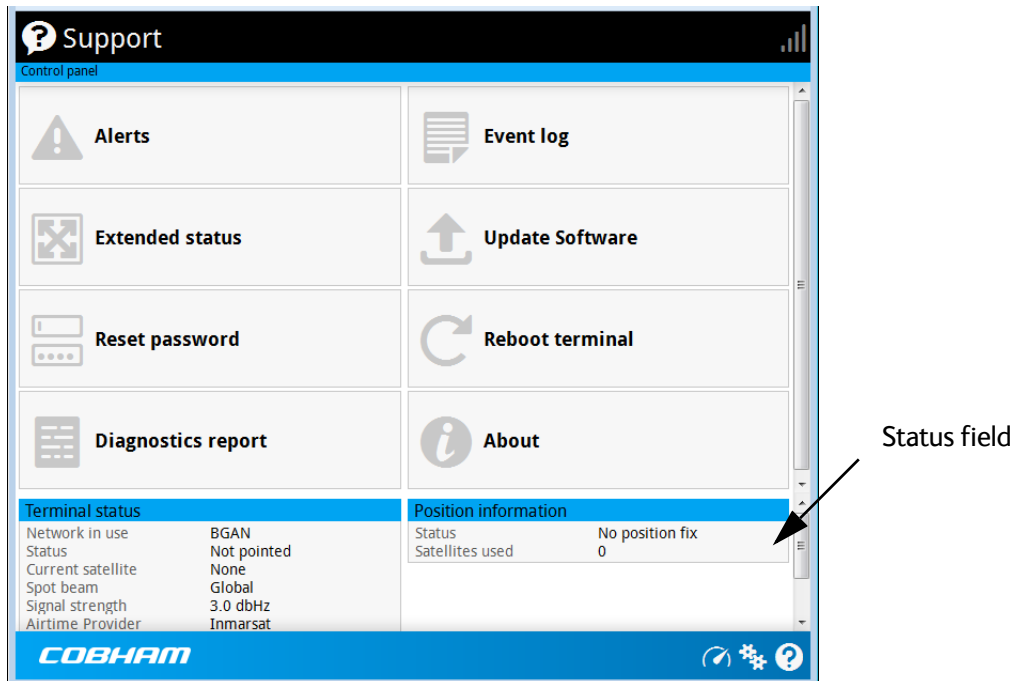

Small screen: Click here for status page



The Control panel

The **Control panel** is used for accessing the settings and functions of your EXPLORER 540.

To open the **Control panel**, click  from the bottom right corner of the web interface.

Note

IP handsets: The M2M subscription does not support Voice over IP (VoIP). For details on VoIP and voice calls with standard class 2 subscription, see Appendix C, *BGAN non-M2M functions*.

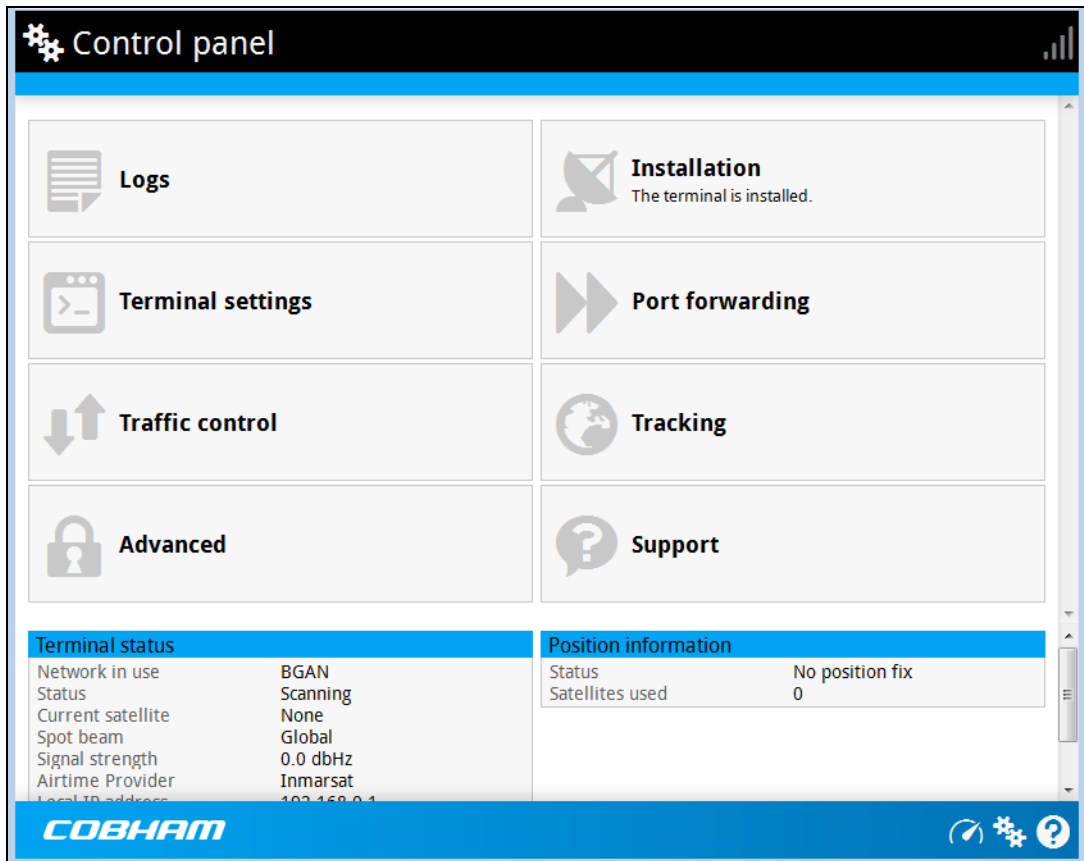

Terminal status	
Network in use	BGAN
Status	Scanning
Current satellite	None
Spot beam	Global
Signal strength	0.0 dbHz
Airtime Provider	Inmarsat
Local IP address	192.168.0.1

Position information	
Status	No position fix
Satellites used	0

To restart the installation process

If you need to restart the installation process, e.g. because the EXPLORER 540 has been moved to another location, click the **Installation tile** in the Control panel. This will reboot the terminal and restart the installation process. For details about the installation process, see *Installation process* on page 11.

To start the installation process from the web interface, do as follows:

1. Select  (Control panel) and then **Installation**.
2. Select **OK** to reboot the terminal and start the installation process. Note that you must log into the web interface with user name and password after reboot. The signal strength is shown on the screen during the pointing process.
3. Turn and tilt the antenna slowly until you have obtained the highest possible signal strength. You can use the pointing sound as well as the signal strength shown on screen. For details, see *Installation process for satellite operation* on page 12.
4. When the EXPLORER 540 has detected a stable BGAN signal it automatically exits the pointing process and starts to connect to the BGAN network.

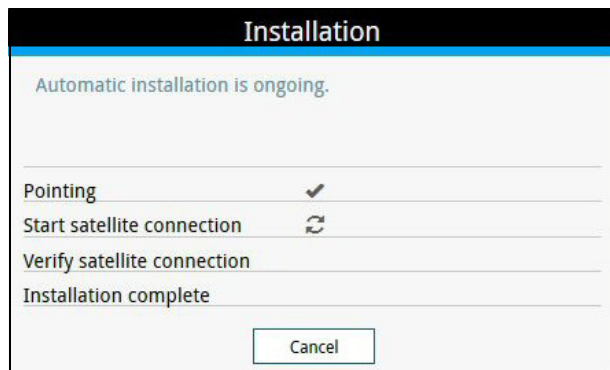

- If you do nothing, the EXPLORER 540 automatically connects to the BGAN network (if possible) and then completes the installation process.
- If you want to cancel installation and start over at next power-up, click **Cancel**. You can still configure the EXPLORER 540, and the LED will be active.

If there are problems with the installation, the web interface will show a warning icon next to the failing step in the installation window. The LED on the EXPLORER 540 will be yellow (warning). See *Troubleshooting guide* on page 78.

5. Tighten the screws to fix the EXPLORER 540 in the pointed position.
6. When the installation process has ended, click **Close** to close the **Installation** window.

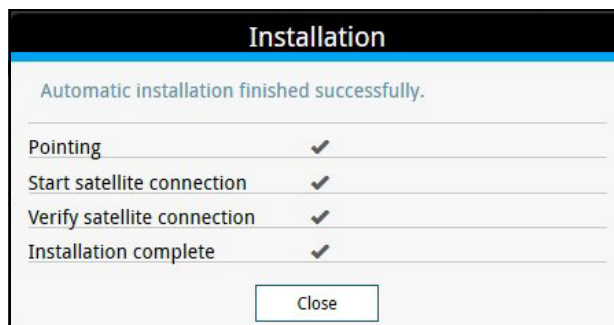

To use the logs

To access the logs

To access the Logs, select  and select **Logs** from the menu. The Logs page contains:

- **Call log:** A list of all incoming, outgoing and missed calls since the log was last cleared.
- **Data log:** A list of all data sessions since the log was last cleared.
- **Total counters:** Totals for each type of service since the log was last cleared.

Date and time is the international UTC time, received from the satellite.

Call log (Non-M2M only)

With Non-M2M subscription the Call log shows:

- **Outgoing calls** shows the start time, receiving end phone number, duration, type (Standard voice or 3.1 kHz audio), termination cause and, if Call charges have been entered, estimated charge of each outgoing call.
- **Received calls** shows the start time, calling phone number, duration, type (Standard voice or 3.1 kHz audio) and termination cause of each incoming call.
- **Missed calls** shows the start time, calling phone number, type (Standard voice or 3.1 kHz audio) and termination cause of each incoming call that was not received.

To clear the Call log, click the **Clear call log** button at the top.

Data log

The Data log shows:

- **Standard data** shows data usage, date and time, termination cause and estimated charge of each Standard data session (if Call charges have been entered).
- **For Non-M2M only: Streaming data** shows the duration and type (such as 64 kbps, 128 kbps), date and time, termination cause and estimated charge of each Streaming data session (if Call charges have been entered).

To clear the Data log, click the **Clear data log** button at the top.

Total counters

The total counters show:

- **For Non-M2M only: Call session totals** shows the total duration (hh:mm:ss) for each call type since the log was last cleared. It also shows the estimated call charge for each call type (if Call charges have been entered).
- **Data session totals** shows totals for each data connection type since the log was last cleared. For Standard data the totals are shown as amount of data transferred (kB) and for Streaming connections the totals are shown in duration (hh:mm:ss). It also shows the estimated charge for each data type (if Call charges have been entered).

To reset the Total counters, click the **Reset total counters** button at the top.

Terminal settings

To configure the terminal settings, select  (Control panel) > **Terminal settings**.

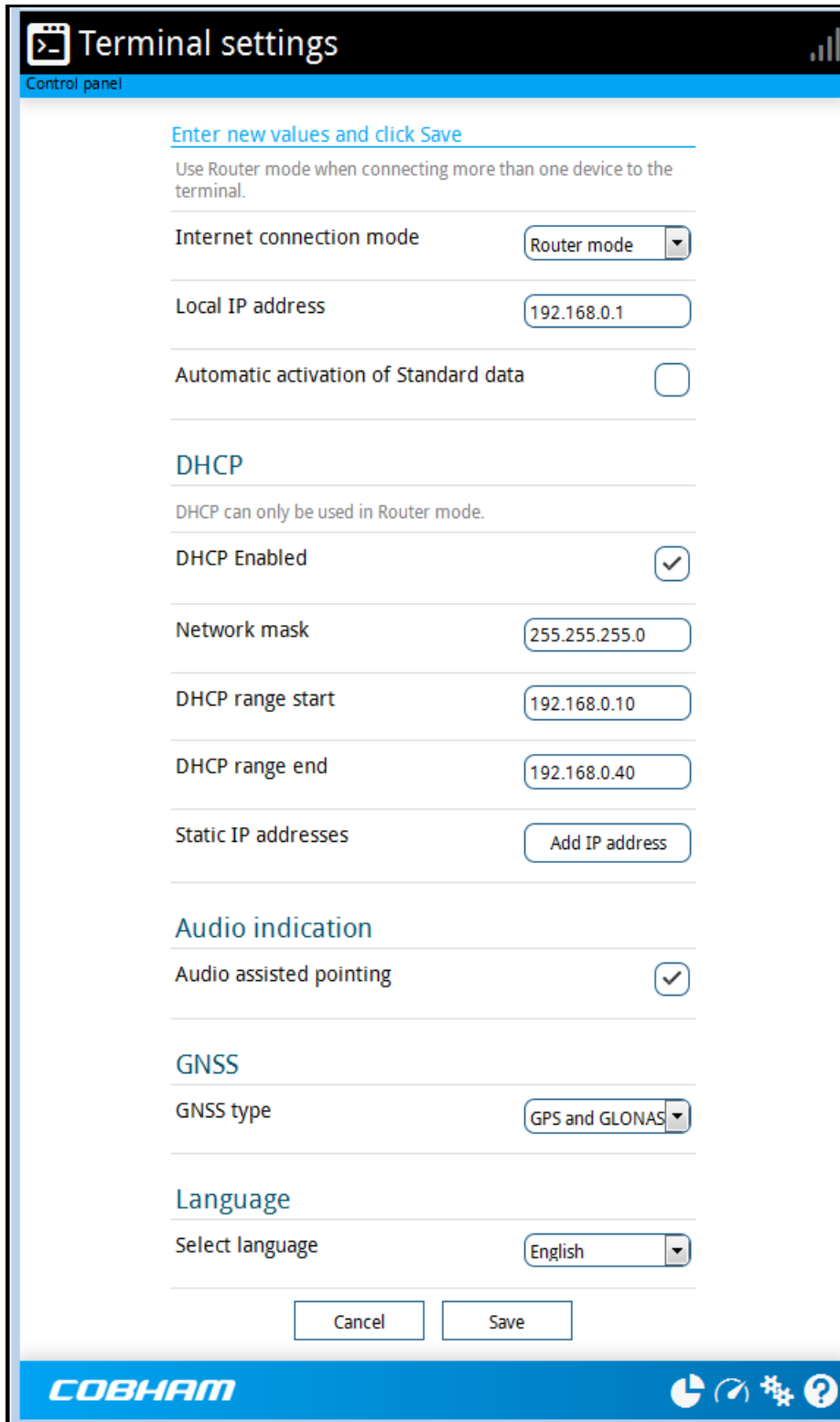

Terminal settings
Control panel

Enter new values and click Save

Use Router mode when connecting more than one device to the terminal.

Internet connection mode

Local IP address

Automatic activation of Standard data

DHCP

DHCP can only be used in Router mode.

DHCP Enabled

Network mask

DHCP range start

DHCP range end

Static IP addresses

Audio indication





Audio assisted pointing

GNSS

GNSS type

Language

Select language

COBHAM    

To set up the connection mode

In the web interface you can set up the Internet connection mode and the IP addressing between the EXPLORER 540 and devices connected to the EXPLORER 540. The EXPLORER 540 has a built-in DHCP server which can be used to dynamically assign IP addresses to devices connected to the EXPLORER 540.

The drawing below shows examples of the IP addressing in router mode (default setup) and modem mode.

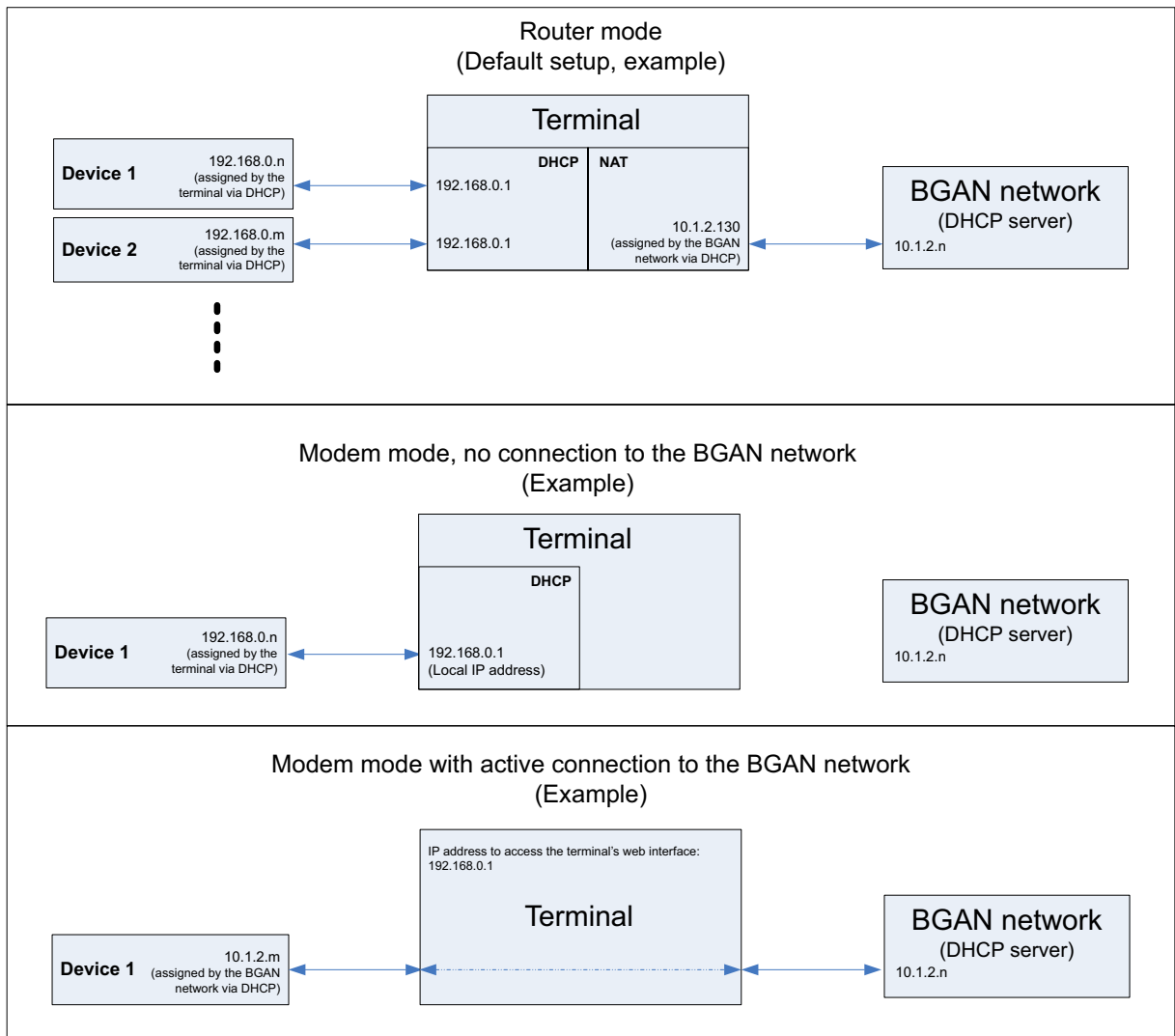

To set up the connection mode of the EXPLORER 540, do as follows:

1. At **Internet connection mode**, select **Modem mode** or **Router mode**. Router mode is the default setting and is recommended for most purposes.
 - Select **Router mode** if one or more computers are connected and the EXPLORER 540 should act as a router. When Router mode is selected, the EXPLORER 540 uses the built-in NAT module for making the necessary address translations.
 - Select **Modem mode** if only one computer is connected, and the EXPLORER 540 should act as a modem, or more than one computer is connected using an external router.

Note

Do **not** connect more than one computer in Modem mode, unless you have an external router.

2. Under **Local IP address**, type in a new IP address if you want to change the Local IP address of the terminal. This is the address used to access the web interface. The default IP address is **192.168.0.1**.

Important

Do **not** use any of the reserved IP addresses listed in *List of reserved IP subnets* on page 88.

3. To enable automatic activation of your data connection, select **Automatic activation of Standard data**.
 - When you **select** automatic activation, the data connection is automatically established after restart as soon as the EXPLORER 540 and its BGAN connection are ready.

Note

You are charged for the data transferred. You may want to disable automatic updates in your LAN device to avoid unnecessary charges.

- When you **disable** automatic activation (default), you can control the data connection manually from the startup page  or with the SMS command ACTIVATE.
4. Under **DHCP**, select **DHCP Enabled** (recommended for most purposes).
 - If you select **DHCP Enabled**, the terminal assigns dynamic IP addresses to devices connected to the terminal.
 - If you select **disable DHCP**, you need to set up a static IP address in the connected device.
 5. If you want to change the **Network mask** for the local network of the terminal, type in the new network mask. The default network mask is **255.255.255.0**.
 6. Under **DHCP range start** and **DHCP range end**, type in the range of IP addresses that should be assigned to locally connected equipment.

7. Under **Static IP addresses** add any static IP addresses used by locally connected equipment. This is necessary in order to be able to access the equipment remotely.

Note

The static IP addresses must be outside the DHCP range set in the previous step.

8. Click **Save**.

To enable or disable the pointing sound

The EXPLORER 540 can make a sound to guide you through the pointing procedure (default enabled). To enable or disable the pointing sound, do as follows:

1. In the **Terminal settings** page, locate the **Audio indication** section.
2. Select **Audio assisted pointing** if you want to use a pointing sound to assist your pointing process.
3. Click **Save**.

To select the type of navigation system (GNSS)

To select which navigation system to use with your EXPLORER 540, do as follows:

1. In the **Terminal settings** page, locate the GNSS section (Global Navigation Satellite System).
2. Select **GPS, GLONASS, GPS and GLONASS** or **BeiDou-1**.
3. Click **Save**. Note that it may take some minutes for the EXPLORER 540 to change the navigation system.

To select the language

The default language of the web interface is **English**. You can change the language to **French, German, Russian, Spanish, Chinese** or **Japanese**.

To change the language, do as follows:

1. In the **Terminal settings** page, locate the **Language** section.
2. Select a language from the list and click **Save**.

Port forwarding

Note

Make the port forwarding configuration before starting the data session.

Port forwarding enables you to set up a server connected to the terminal while the terminal is in Router mode. Without port forwarding it would not be possible to contact the server from the Internet. We recommend using a static public IP address for the terminal in order to provide easy access to the terminal. To use the static IP address, it must be included in your subscription and you must set the APN source to SIM default. For details, see *To change the APN for a connection package* on page 43.

Do as follows:

1. From the **Control panel** , select **Port forwarding**.
2. Select **Forward port** to add a new port forwarding.
3. Select **Active** to activate the port forwarding.
4. Type in the **Incoming port start** and the **Incoming port end**.
This is the range of port numbers on the EXPLORER 540 for which incoming traffic to the EXPLORER 540 will be forwarded.
5. Type in the **Destination IP** address, which in this example is the IP address of the mail server: 192.168.0.100.
This is the IP address to which the incoming traffic is forwarded.
6. Type in the **Destination port start** and the **Destination port end**.
This is the range of port numbers at the server, to which the incoming traffic will be forwarded. If only a single port is used, type the same port for **Destination port start** and **Destination port end**.
7. Click **Save**.

When you have activated a data connection, you can now access the server from the Internet, using the external IP address of the terminal. If you are using the web interface, you can see the external IP address in the tile with the data connection you have started. For information on how to activate your data connection, see *To control data connections (PDP contexts)* on page 29.

To manage connected devices (Traffic control)

By default, traffic control is disabled, which means that all traffic is allowed.

With the Traffic control function you can get an overview of devices connected locally to your EXPLORER 540 and control which devices you want to connect. You can also select whether or not they should be allowed to use the BGAN network. Note that the available settings depend on whether or not you are logged in as administrator.

Traffic control (Non-administrator user)

To set up traffic control, do as follows:

1. In the **Control panel** , click **Traffic control**.
A list of connected and added devices appears.

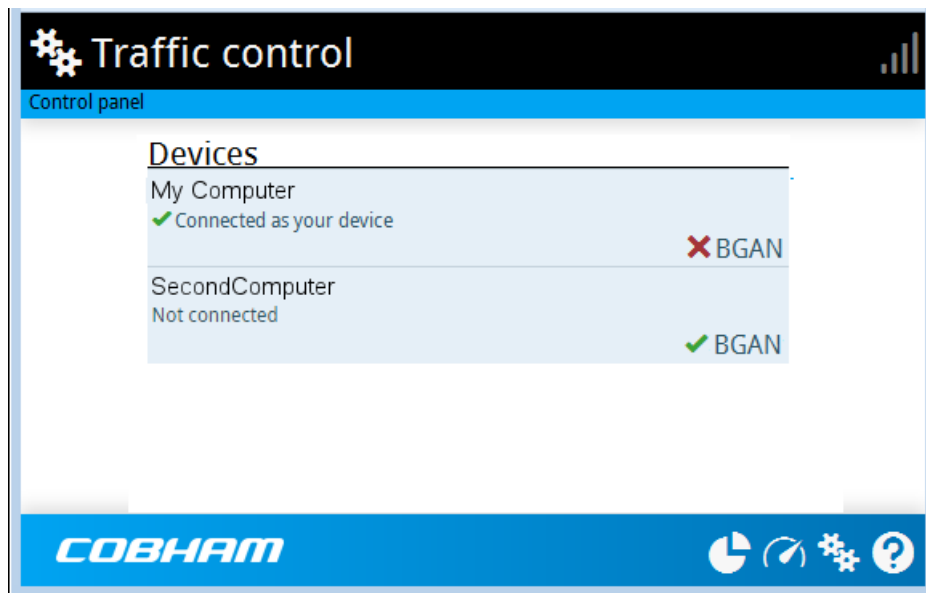

2. Click your connected device to see MAC address and IP address and to change the name or block/allow the use of BGAN network. See the next section.

To block BGAN traffic or edit the name for your device

Note You can only change these settings if traffic control is enabled. If the administrator has disabled traffic control, all traffic is allowed.

1. In the **Traffic control** page, click your connected device.
The page shows the name, MAC address, IP address and traffic rule for the device.
2. Select **Block BGAN traffic**, if you want to deny access to the BGAN network for your device.

Note If it is already blocked by the administrator, this setting is not editable.

3. At **Name**, type in the name you want for your device.
4. Click **Save**.

Traffic control (administrator)

When you are logged in as administrator, the Traffic control setup offers more options. To set up traffic control as administrator, do as follows:

1. Log in as administrator.
2. In the **Control panel** , click **Traffic control**.
A list of connected and added devices appears.
3. Click the **Enable** button to enable Traffic control.
By default Traffic control is disabled, which means all devices are allowed access.



To change the default settings for all devices

Important | All devices in the list are updated with the default settings when you click Save.

1. Click the button **Default settings**.
2. Select **Block BGAN traffic** if you want to deny access to BGAN network for all devices. With this option selected, only the administrator will be able to allow access for selected or all devices.
3. Click **Save**.
All devices in the list will now have the new default settings.

To block or allow BGAN traffic or edit the name for a device

1. In the **Traffic control** page, click the device you want to set up.
The page shows the name, MAC address, IP address and traffic rule for the device.
2. Select **Block BGAN traffic**, if you want to deny access to the BGAN network for the selected device.
If you want to allow access, clear the box. The selected device will then be able to access the network, even if it is blocked in the default settings (see previous section).
3. At **Name**, type in the name you want for your device.
4. Click **Save**.

To Add a device

When you connect a device, it is automatically added to the list using the default settings. If you want to add a device for later use, do as follows:

1. In the **Devices** page, click the **Add device** button.
2. Type in the **Name** and the **MAC address** for the device.
3. Select **Block BGAN traffic**, if you want to deny access to BGAN network for the selected device.
If you want to allow access, clear the box. The selected device will then be able to access the network, even if it is blocked in the default settings (see previous section).
4. Click **Save**.

When the device with this MAC address is connected, it will appear with the entered name in the list, and access will be allowed or denied depending on the setting in this page.

To set up tracking

You can set up the EXPLORER 540 to report to a server at certain time intervals. To set up tracking, do as follows:

1. From the Control panel , select **Tracking**.

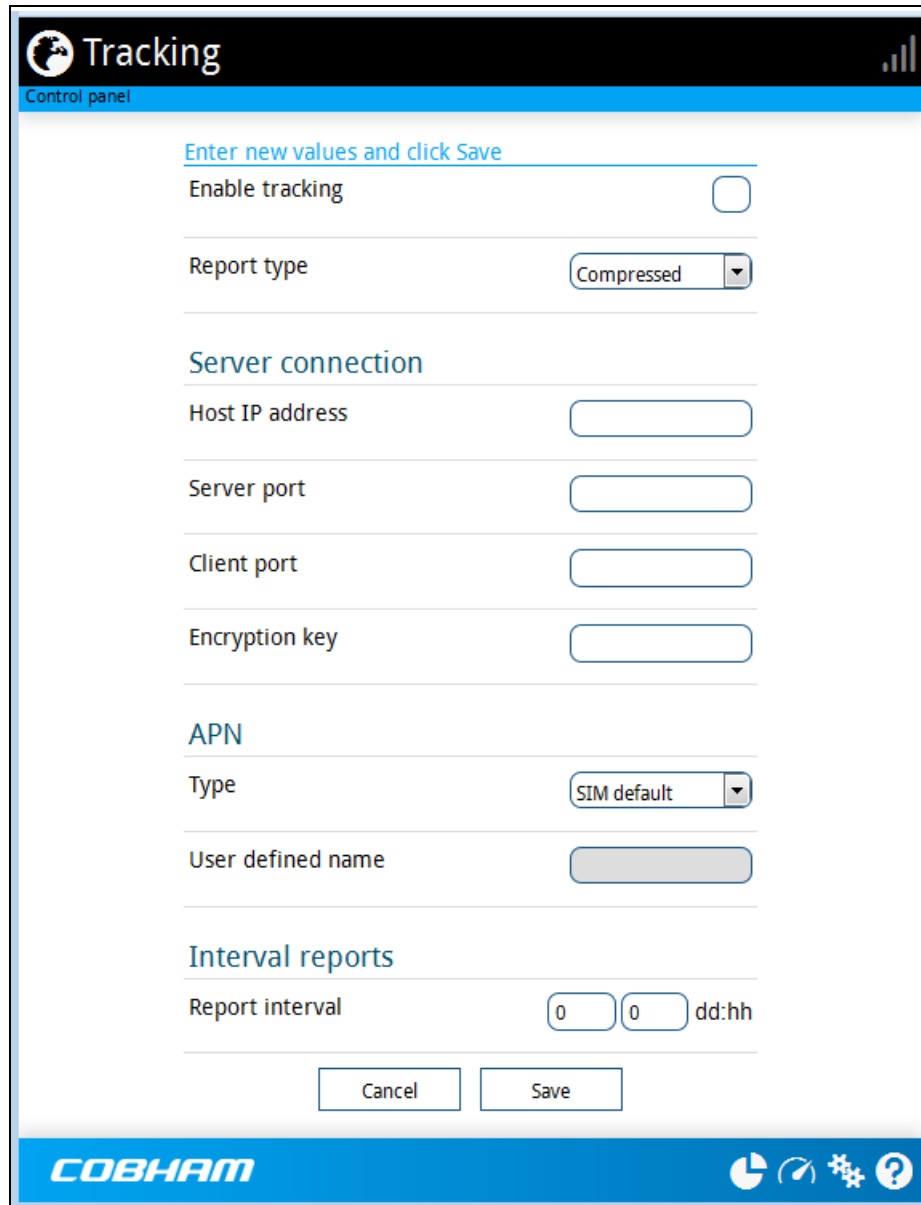

Tracking
Control panel

Enter new values and click Save

Enable tracking

Report type Compressed

Server connection

Host IP address

Server port

Client port

Encryption key

APN

Type SIM default

User defined name

Interval reports

Report interval dd:hh

COBHAM

2. To enable tracking of the EXPLORER 540, select **Enable tracking**.
3. Select the **Report type**.
 - **Compressed**. Only latitude and longitude are reported.
 - **Extended**. Apart from latitude and longitude, heading and altitude are also included.
 - **ECEF**. The same information as Extended, but position and speed data are 3D (ECEF coordinates).
4. Under **Server connection**, type in the following details:

- **Host:** The IP address of the server that the EXPLORER 540 will report to.
 - **Server port:** Port number on the server. Default number is 7474.
 - **Client port:** Port number on the EXPLORER 540. Default number is 7475.
 - **Encryption key:** A 128 bit key which must match on both the client and server side. Supplied from the server manager.
5. Under **APN**, select the source of the APN.
 - **SIM default** (recommended): The APN is taken from the SIM card.
 - **Network assigned:** The APN is assigned from the network.
 - **User defined:** APNs are provided from the Airtime Provider. Type in the APN next to **User defined name**.
 6. Type in the **Report interval** in days (dd) and hours (hh).

Example: If you type in “01” and “12”, the EXPLORER 540 will send a report for every 1½ day.

Note | If the EXPLORER 540 is in power save mode, no report is sent!

7. Click **Save**.

You can see the status of the tracking link in the status area of the web interface. If the status area is not shown, click  to see it.

Note | You can set up whether or not you want to allow the tracking server to control these settings. See *Remote control of tracking* on page 70.

Support features

To open the Support page, select  (Control panel) > **Support**.

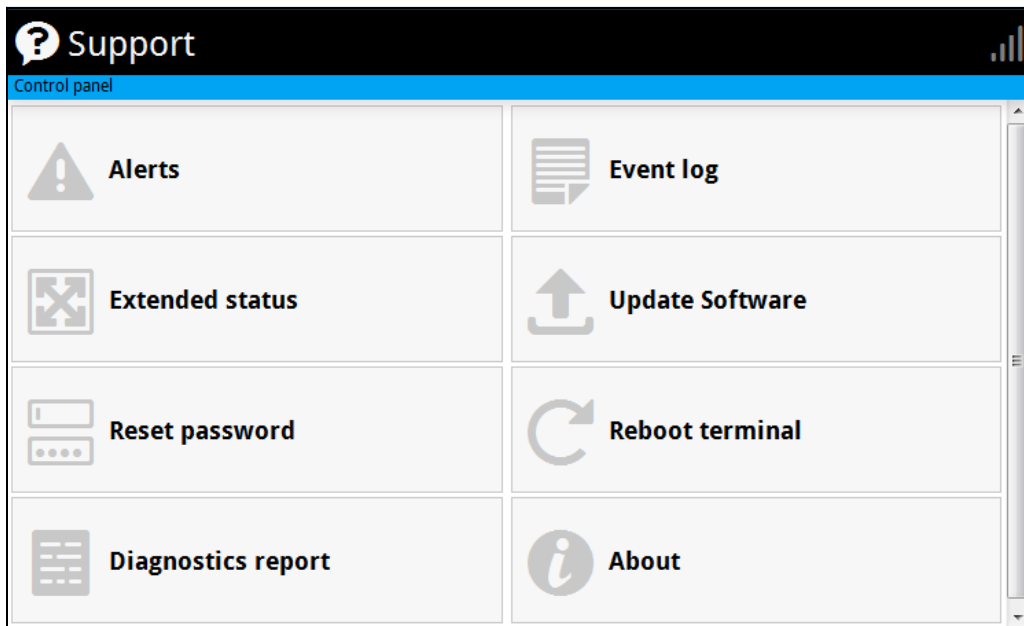

To view the Alerts

When an alert is registered, the web interface shows a warning icon  in the icon bar as long as the alert is active. The **Alerts** list only shows alerts that are currently active.

1. To view the alerts, click  from the icon bar at the top of the web interface, or select **Alerts** from the **Support** page.

The **Alerts** page shows a list of active events. For more information on the event messages, refer to *List of messages* on page 82.

To view the Event log

The Event log shows events that occurred in the past and are no longer active. It includes events of informational character describing normal phases of operation for the terminal, and also alerts that have appeared in the Alerts list.

To view the event log, select **Event log** from the **Support** page.

To create a diagnostics report

The diagnostic report contains relevant information for troubleshooting. When contacting your supplier for support, please enclose this file. To generate a diagnostic report, do as follows:

1. From the **Support** page, click **Diagnostics report**.
2. Click **Generate report**.

Note | It may take a few minutes to generate the report.

3. Select **Download report**.
4. Choose a location for the file and save it.

To update software

To update the software in the EXPLORER 540 using the web interface, do as follows:

1. Download the new software¹ or acquire the software from Cobham SATCOM and save it on your computer.
2. Open the web interface and enter the Control panel .
3. Click **Support > Update software**.
4. Click **Update software...**
5. Browse to the new software version and click **Open**. The software file has the extension “.tiff”.
6. The terminal restarts and completes the software update.

Note

The update procedure takes some minutes to complete. If the installation process has not yet been completed, the Status LED flashes blue during the software update.

You can check the software version under **Control panel > Support > About**.

To view extended status

To see the Extended status page, select **Support > Extended status**.

To view updated information on the **Extended status page**, click the icon in the top left corner to refresh the page.

The Extended Status page shows information such as IAI-2 status, IMSI number and IMEI number.

1. You can download the software from the “Self Service Centre” at www.cobham.com/satcom, select **Service and Support > Cobham SATCOM Service and Support** and then **24-7 Self Service Centre / Technical Downloads**. Locate the EXPLORER 540 software.

To reset the administrator password

If you have forgotten the administrator password, do as follows:

Note | If you have physical access to the EXPLORER 540, you can also use the Reset button. For details, see *Reset button* on page 77.

1. Contact your supplier for a reset code.
Report the serial number and IMEI number of the terminal.
You can find the serial number under **Control panel > Support > About** and the IMEI number under **Control panel > Support > Extended status**.
2. After receiving the reset code from your supplier, select **Reset password** from the **Support** page.
3. Type in the reset code obtained from your supplier and click **Reset**.
4. The password is reset to **admin**.

To restart the terminal

If you want to restart the terminal, do as follows:

1. From the **Support** page, select **Reboot terminal**.
2. Click to confirm the reboot.
The terminal restarts. Note that this is the equivalent to switching the terminal off and on again. It is **not** the same as pushing the Reset button, the installation process will not restart.

About

The **About** page shows the **Serial number** and **software version** of your EXPLORER 540 and legal information. It also shows your **Help desk** information, if it has been entered under **Advanced > Help desk**.

To access the About page, select **Support > About**.

Advanced settings

Passwords

The EXPLORER 540 web interface is password protected at two levels: A user password and an administrator password. You will always be prompted for a password when you access the web interface.

Default settings are:

- **User:** User name: **user**, Password: <serial number of the EXPLORER 540>
- **Administrator:** User name: **administrator**, Password: **admin**

You can change the passwords if you are logged in as administrator, see the next sections.

To log in as administrator

Access to the Advanced settings requires an administrator password. If you are already logged in as user and you want to access the **Advanced** settings, do as follows:

1. From the Control panel , select **Advanced**.
If you are not logged in as administrator you are now prompted to log in.
2. Enter the administrator password.
If you have forgotten the administrator password, you can reset the password. For details, see *To reset the administrator password* on page 61. The old user name and password will apply until you have finished the reset procedure.
3. Click **Login**.

To change the user password

To change the user password, do as follows:

1. Log in as administrator
2. Under **Advanced**, select **Change user password**.
3. Type in the **Old password**.
4. Type in the **New password** and retype it on the next line.
5. Click **Save**.
At the next login the new password is required.

To change the administrator password

To change the administrator password, do as follows:

1. Log in as administrator
2. Under **Advanced**, select **Change admin password**.

3. Type in the **Old password**.
4. Type in the **New password** and retype it on the next line.
5. Click **Save**.
At the next login the new password is required.

To log out as administrator

If you close the web interface, you are logged out automatically after 30 seconds. To log out manually, click **Logout administrator** in the **Advanced** page.

To set up user permissions

You can allow or deny users access to certain functions and make these pages read-only. This is useful if you want to protect the system against unintended changes. Study this screen thoroughly and decide to which areas of the system you want to give non-administrator users access. To set up the user permissions, do as follows:

1. Under **Advanced**, select **User permissions**.
2. Under **Allow users to:**, select the settings you want to **allow** users to access.
3. Under **Allow AT commands on:**, select **LAN interface** if you want to allow the use of AT commands.
4. Under **Allow user accounts:**, select **Service user account** if you want to enable the use of a service user account.
5. Click **Save**.

The settings without a check mark can only be viewed but not changed by the non-administrator user.

To restore factory settings

To restore the factory settings of the EXPLORER 540, do as follows:

1. Under **Advanced**, select **Factory reset**.

Important

All configuration will be lost and the EXPLORER 540 will return to the default configuration.

2. Click **OK**.

The terminal will now restart and start up with the factory settings. The installation process is also restarted.

SIM PIN for BGAN

To enable or disable the use of a SIM PIN

To enable or disable the use of a PIN to access the BGAN network, do as follows:

1. Under **Advanced**, select **SIM**.
2. Select **Enable/disable SIM PIN**.
3. Under **Enable/Disable PIN** select or clear the box next to **Require PIN on startup**.
 - If you clear the box, you can access and use the terminal without entering a PIN
 - If you select the box, you must enter a PIN on startup before you can make calls or data sessions
4. If you selected Require PIN on startup, type in the PIN next to **Enter current PIN**.
5. Click **Save**.
The new PIN settings will take effect at next power on.

To change the SIM PIN

To change the PIN used to access the BGAN network, do as follows:

1. Under **Advanced**, select **SIM**.
2. Select **Change SIM PIN**.
3. Under **Change PIN** type in the **Current PIN**.
4. Type in the **New PIN** and retype it on the next line.
5. Click **Save**. The new PIN settings will take effect at next power on.

Auto SIM PIN validation

The Auto SIM PIN validation feature allows the EXPLORER 540 to automatically send the PIN to the SIM at power up. This enables the SIM to be PIN locked (to prevent unauthorised re-use of the SIM elsewhere), while still allowing the EXPLORER 540 to connect to the BGAN network without using a PIN.

When this feature is enabled, the PIN you enter when setting the Auto SIM PIN validation feature is encrypted and stored locally in the EXPLORER 540. The next time the EXPLORER 540 restarts, the terminal decrypts the PIN and automatically sends it to the SIM without user intervention.

Note | The SIM PIN must be enabled before you can use this feature. See *To enable or disable the use of a SIM PIN* on page 64.

To set up the Auto SIM PIN validation feature, do as follows:

1. Under **Advanced**, select **SIM**.

2. Select **Auto SIM PIN validation**.
3. Select **Automatically validate SIM PIN on startup**.
4. Enter the PIN.
5. Click Save.

Note If the SIM PIN is changed either using the web interface or AT commands, the Auto SIM PIN validation feature is disabled and must be reenabled manually.

Note If the SIM card is replaced without disabling the Auto SIM PIN validation feature, and the first verification of the SIM PIN fails, the Auto SIM PIN validation feature will disable itself to avoid locking the SIM card.

SIM lock

The SIM lock feature can be used by suppliers to lock your SIM card to a specific provider or distribution partner. For further information, contact your supplier.

To save or load a configuration

If you need to reuse a configuration in other terminals of the same type, you can save your current configuration to a file, which can then be loaded into the other terminal(s).

Note Be aware that if the terminals have different software versions, some of the settings may be different than expected. If possible, use the same software version in the terminals.

To save a configuration to a file

To save the current configuration of your EXPLORER 540 to a file on your computer, do as follows:

1. In the **Advanced** page, click **Load/save configuration**.
2. Click **Save configuration**.
The configuration file is saved in the EXPLORER 540.
3. Click **Download configuration...**
The configuration is downloaded from the EXPLORER 540 to the downloads section of your computer.

To load a configuration from a file

To load a configuration from a file into your EXPLORER 540, do as follows:

1. In the **Advanced** page, click **Load/save configuration**.
2. Click **Load configuration**.

3. Browse to the configuration file and click **Open...**

The configuration is now loaded into your EXPLORER 540. When the configuration is loaded successfully, the EXPLORER 540 restarts with the new configuration.

Link monitoring

It is strongly recommended to use link monitoring to monitor your locally established IP connection, as it enables you to test the BGAN connectivity and to keep your PDP context alive.

With this feature activated, the terminal will send out ping commands to up to three servers of your choice. When a data session is started, the terminal will start sending ping commands to the Primary IP address the number of times specified. If no response is received, it will send the same number of ping commands to the Secondary and then the Tertiary IP address, if available. If no response is received from any of the IP addresses, the terminal will eventually restart.

Note | The data connection must be activated before link monitoring can start. See *To start and stop data connections* on page 42.

To set up link monitoring, do as follows:

1. Under **Advanced**, select **Link monitoring**.
2. Select **Enable Link monitoring**.
3. At **Ping interval (minutes)** select the Interval in minutes between the ping commands.
4. Select the **Number of retries** before the terminal restarts.
5. Select the **Ping mode**.
 - **Ping always**: Always send ping, regardless of data traffic.
 - **Ping when no traffic**: Send ping only if no data traffic is ongoing.
6. Type in the Primary and optionally the Secondary and Tertiary IP address. This is the IP address of the server(s) to which the terminal will send ping commands.

Note | Use a server that is reliable and that responds to ICMP Echo Requests.

7. Click **Save**.

Data limits

You can set a limit for the use of data services with the EXPLORER 540 system.

If you have entered the call charges in the menu **Call charges**, the system automatically calculates and displays the estimated maximum charges for your data sessions.

Note Thrane & Thrane A/S does not take responsibility for the correctness of the estimated charges. This calculation is only a rough estimate of the charge, based on the tariff entered by the user. Also, the airtime provider may have different methods of calculating the charge.

Once the entered limit is reached, the connection is automatically stopped. This is recorded in the data log. To continue using the data service you must start a new connection by clicking on the desired connection on the startup page.

Note If you have enabled automatic activation of the Standard data connection and you set a data limit for the Standard data connection, automatic activation is disabled.

To set data limits, do as follows:

1. Under **Advanced**, select **Data limits**.
2. Select the type of connection you want to limit.
3. Type in the amount of data or time allowed and select the appropriate units.
4. Select **Enable**.
5. Click **Save** to save the settings.

Call charges

Note Thrane & Thrane A/S does not take responsibility for the correctness of the estimated charges. This calculation is only a rough estimate of the charge, based on the tariff entered by the user. Also, the Airtime Provider may have different methods of measuring the airtime used.

If you know the tariff for your subscribed services, you can enter these tariffs in the web interface and automatically calculate the estimated charges for your calls and data sessions. To enter the call tariffs, do as follows:

1. Under **Advanced**, select **Call Charges**.
2. Select the currency from the **Displayed currency** drop-down list.
3. Enter the tariff for each of the services.
4. Click **Save**.

The entered tariffs are used for estimating the charges for calls and data sessions. For further information, see *Call log (Non-M2M only)* on page 48.

Remote management

You can set up the terminal so that it can be controlled from a remote location.

To set up the terminal for remote management, select **Advanced** > **Remote management** from the **Control panel**.

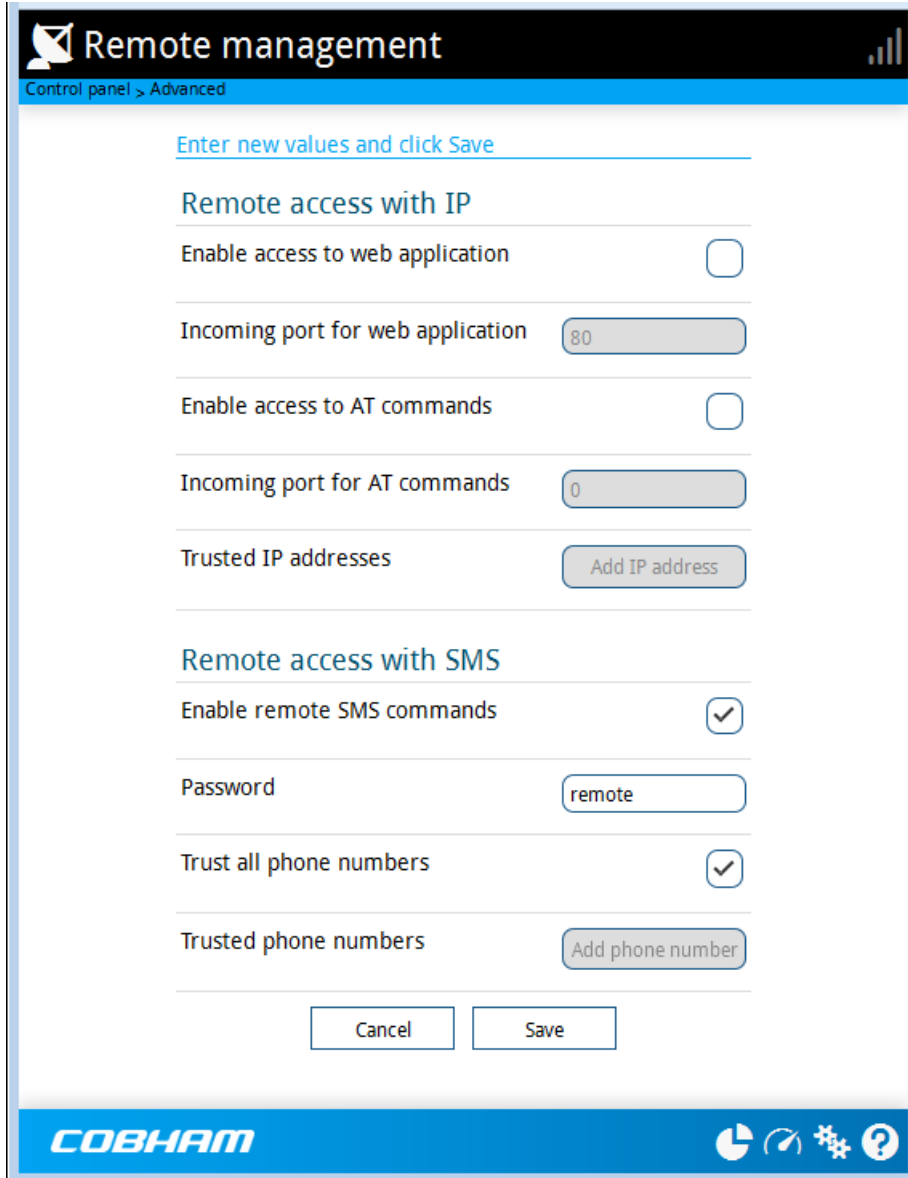

The screenshot shows the 'Remote management' configuration page. At the top, there is a header with the COBHAM logo and the text 'Remote management'. Below the header, there is a breadcrumb trail: 'Control panel > Advanced'. A blue bar contains the instruction 'Enter new values and click Save'. The page is divided into two main sections: 'Remote access with IP' and 'Remote access with SMS'. Under 'Remote access with IP', there are four settings: 'Enable access to web application' (checkbox), 'Incoming port for web application' (text input with '80'), 'Enable access to AT commands' (checkbox), and 'Incoming port for AT commands' (text input with '0'). Below these is a 'Trusted IP addresses' section with an 'Add IP address' button. Under 'Remote access with SMS', there are four settings: 'Enable remote SMS commands' (checkbox checked), 'Password' (text input with 'remote'), 'Trust all phone numbers' (checkbox checked), and 'Trusted phone numbers' (text input with 'Add phone number' button). At the bottom of the form are 'Cancel' and 'Save' buttons. The footer of the page features the COBHAM logo and several icons: a pie chart, a refresh arrow, a gear, and a question mark.

To set up remote access with IP

Note | The settings for Remote access with IP are **not** relevant if you are using the **_IREMWEB** command. See *To use AT commands to get remote access to the web interface* on page 25.

1. From the **Remote management** page, select **Enable access to web application** and/or **Enable access to AT commands**.
2. Type in the **Incoming port** numbers to use for the web server and for AT commands. The default port numbers are:
 - web server: 80
 - AT commands: 5454

Note | If you type another port number, the port number must be available at your service provider.

3. Under **Trusted IP addresses**, click **Add IP address** and type in the IP address of the device you want to give access to the terminal.
4. To add more IP addresses, click **Add IP address** again.

Note | To be able to access the terminal you must have an active data connection.

After preparing the terminal and activating the connection you can access the terminal from one of the trusted IP addresses, using the incoming port defined in the Incoming port field.

- For information on how to prepare the terminal for remote activation of a data connection, see the next section *To set up remote access with SMS*.
- For information on how to access the terminal, see *To access the terminal from a remote location* on page 20.

If Static IP is included in your airtime subscription, we recommend using this static public IP address for the terminal in order to provide easy access to the terminal. To use the static IP address, it must be included in your airtime subscription and you must set the APN source to SIM default. For details, see *To change the APN for a connection package* on page 43.

To set up remote access with SMS

Note | The terminal must be registered to the satellite services to receive and accept an SMS.

1. From the **Remote management** page, select whether you want to **Enable remote SMS commands**.
2. Enter the password for remote SMS. It can be up to 32 characters long. The characters 0-9, a-z and A-Z are allowed. **The password is mandatory**. This password must be entered every time you send an SMS command. Default password is **remote**.

- Clear the box **Trust all phone numbers** and enter at least one trusted mobile number from which the terminal accepts an SMS. Use the wild card * to accept a range of trusted numbers. Leave out the prefix before the country code (example: for "+45" write only "45")

Entered mobile number with wild card	Mobile numbers accepted
453955880*	+4539558800 to +4539558809
45395588*	+4539558800 to +4539558899

- To add more phone numbers, click **Add phone number** again.
- Click **Save**.

For information on how to send SMS commands, see *Remote access with SMS* on page 20.

Remote control of tracking

When you are using the tracking function of the EXPLORER 540, you can set up the terminal so that the tracking server can access the EXPLORER 540 e.g. to start or stop tracking or to change reporting intervals.

To allow the tracking server to control the tracking settings, do as follows:

- Under **Advanced**, select **Tracking settings**.
- Select **Allow remote control of tracking**.
- Click **Save**.

The EXPLORER terminal will now accept commands from the specified tracking server, for example to change reporting intervals or start/stop reporting.

Power save (Settings)

There are a number of options to save power in the EXPLORER 540. For a general description of the power save options, see *Power-saving* on page 31.

To set up the power save options, do as follows:

1. Under **Advanced**, select **Settings**.

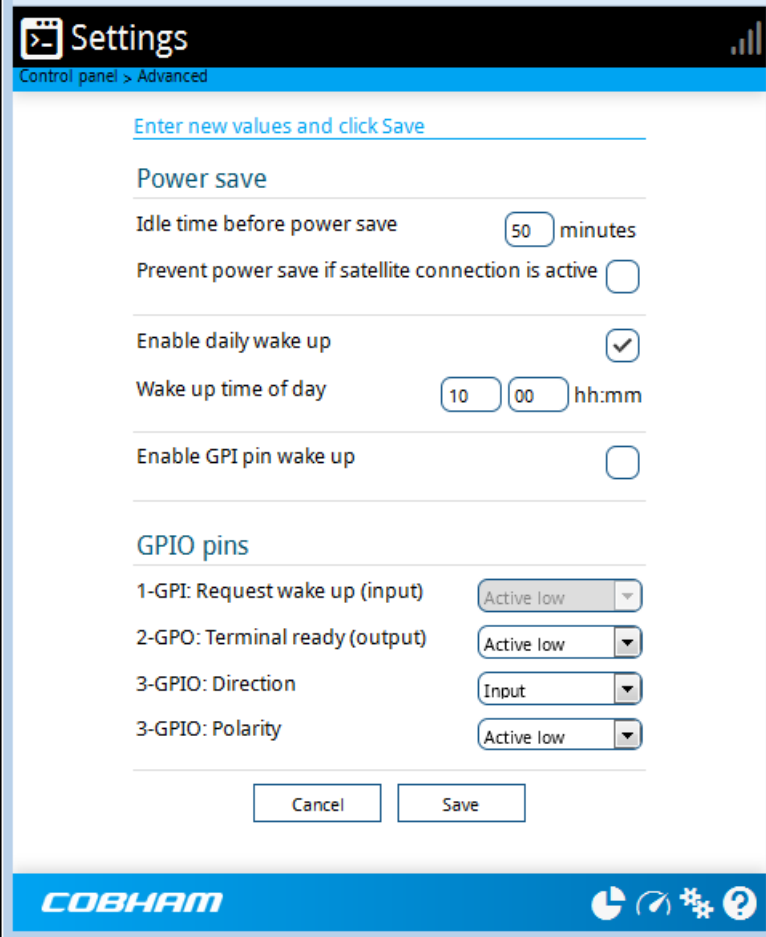

The screenshot shows the 'Settings' page under 'Advanced'. The page title is 'Settings' and the breadcrumb is 'Control panel > Advanced'. Below the title, there is a link 'Enter new values and click Save'. The main section is 'Power save', which includes the following options:

- Idle time before power save: 50 minutes
- Prevent power save if satellite connection is active:
- Enable daily wake up:
- Wake up time of day: 10:00 hh:mm
- Enable GPI pin wake up:

Below the 'Power save' section is the 'GPIO pins' section, which includes the following options:

- 1-GPI: Request wake up (input): Active low
- 2-GPO: Terminal ready (output): Active low
- 3-GPIO: Direction: Input
- 3-GPIO: Polarity: Active low

At the bottom of the form are 'Cancel' and 'Save' buttons. The COBHAM logo and navigation icons are visible at the bottom of the page.

2. Select how many minutes with no (local) activity before the terminal should enter power save mode (Idle time).

Note If you select 0 (zero), the power save function is disabled and the terminal will never enter power save mode.

3. Select **Prevent power save if satellite connection is active** if you do not want the terminal to enter power save mode when a data connection (PDP context) is opened on the satellite connection.

Note With this option selected, the terminal will not enter power save mode if there is a PDP context open, even if it is not currently used to send or receive data.

4. Select **Enable daily wake up** and enter the **Wake up time of day** if you want the terminal to “wake up” from power save mode at a specific time every day.

Note | Local time must be converted to UTC time!

5. Select **Enable GPI pin wake up** if you want to use the dedicated I/O pin on the EXPLORER 540 to wake up the terminal from power save mode. See the next section *I/O pins (Settings)* on page 72.
6. Click **Save**.

I/O pins (Settings)

The EXPLORER 540 has 3 I/O pins, two assigned pins and 1 general purpose pin.

- Request wake up (input)
- Terminal ready (output)
- Control/Status input/output

1. Under **Advanced**, select **Settings**.

The screenshot shows the 'Settings' page with the following configuration:

- Power save:**
 - Idle time before power save: 50 minutes
 - Prevent power save if satellite connection is active:
 - Enable daily wake up:
 - Wake up time of day: 10:00 hh:mm
 - Enable GPI pin wake up:
- GPIO pins:**
 - 1-GPI: Request wake up (input): Active low
 - 2-GPO: Terminal ready (output): Active low
 - 3-GPIO: Direction: Input
 - 3-GPIO: Polarity: Active low

Buttons: Cancel, Save

2. If you have enabled GPI pin wake up, select whether the Request wake up input should be active high or low.
3. Select whether the **Terminal ready** output should be active high or low. This output signals when the EXPLORER 540 is ready to communicate with connected equipment.

Note

“Terminal ready” only signals that the terminal is awake and ready to communicate with connected equipment. It does **not** show whether or not the terminal is registered on the network, or a data connection is established. See *Power-saving* on page 31 and *Automatic Context Activation (ACA)* on page 29.

4. If you want to use GPIO pin 3, select the direction and polarity. Pin 3 does not have a predefined function, but can be used for remote control/status of connected M2M equipment using AT command `_ITGPIO`. See *Control or status with GPIO pin 3* on page 37.
5. Click **Save**.

Help desk

Under Help desk you can enter the contact information you want for your EXPLORER 540. The Help desk contact information is empty by default. You must provide the contact information, e.g. the phone number for your Airtime Provider. Do as follows:

1. In the **Advanced** page, select **Help desk**.
2. Type in the contact information you want.
3. select **Save**.

The Help desk information is now available from  (Control panel) > **Support** > **About**.

Reset button

You can change the function of the Reset button. See *Reset button* on page 77. Do as follows:

1. From the **Advanced** page, select **Reset button**.
2. Select the behavior you want for the Reset button.
 - **Enabled:** Short push: The EXPLORER 540 restarts (power cycle) and begins the installation process again., Long push: Reset to factory default.
 - **Long press disabled:** The Reset button will not be able to reset to factory default, but the short push function will still work.
 - **Disabled:** The Reset button will not have any function.
3. Click **Save**.

To enter the SIM PIN in the web interface

Do you need a SIM PIN?

Note

You may not have to enter a SIM PIN to access the terminal. This depends on whether or not the use of a SIM PIN is enabled on your SIM card and whether or not the Auto SIM PIN validation is used.

The administrator can enable and disable the use of a SIM PIN and set up Auto SIM PIN validation. For details, see

- *To enable or disable the use of a SIM PIN* on page 64
- *Auto SIM PIN validation* on page 64

If a computer is connected when you start up the terminal, you can access the web interface and enter the SIM PIN here.

Important

If your EXPLORER 540 is used in an unmanned M2M system, you will normally not be able to enter a PIN code. In this case we strongly recommend enabling **Auto SIM PIN validation** in the web interface before using the system. See *Auto SIM PIN validation* on page 64.

To enter the SIM PIN

If your SIM card requires a PIN and the PIN has not yet been entered, you must enter it before you can make calls or access the Internet. Until you have entered the PIN you cannot access the network, but you can still configure your terminal.

To enter the PIN, do as follows:

1. Access the web interface.
If the terminal needs a PIN, a popup window tells you to enter PIN.
2. Type in your PIN and click **OK**.

When pointing is completed and the correct PIN is entered, you are ready to make calls or access the Internet.

To cancel the SIM PIN

If you select **Cancel** when you are asked for a PIN, you can use the web interface as normal, but you will not be able to access the network to make calls or data sessions.

To enter the PIN later, after cancelling the first time, do as follows:

1. From the icon bar at the top, click .
The **Alerts** list opens.
2. Click **Resolve** next to **Enter PIN for BGAN**.
3. Type in your PIN and click **OK**.

Maintenance and troubleshooting

Support

Contact information

Should your Cobham SATCOM product fail, please contact your dealer or installer, or the nearest Cobham SATCOM partner. You will find the partner details on www.cobham.com/satcom where you also find the Cobham SATCOM Self Service Center web-portal, which may help you solve the problem. Your dealer, installer or Cobham SATCOM partner will assist you whether the need is technical support, arranging on-site repair or sending the product for repair. Your dealer, installer or Cobham SATCOM partner will also take care of any warranty issue.

To repack for shipment

Should you need to send the product for repair, please read the below information before packing the product.

The shipping carton has been carefully designed to protect the EXPLORER 540 and its accessories during shipment. This carton and its associated packing material should be used when repacking for shipment. Attach a tag indicating the type of service required, return address, part number and full serial number. Mark the carton FRAGILE to ensure careful handling.

Note | Correct shipment is the customer's own responsibility.

If the original shipping carton is not available, the following general instructions should be used for repacking with commercially available material.

1. Wrap the defective unit in heavy paper or plastic. Attach a tag indicating the type of service required, return address, part number and full serial number.
2. Use a strong shipping container, e.g. a double walled carton.
3. Protect the front- and rear panel with cardboard and insert a layer of shock-absorbing material between all surfaces of the equipment and the sides of the container.
4. Seal the shipping container securely.
5. Mark the shipping container FRAGILE to ensure careful handling.

Failure to do so may invalidate the warranty.

Software update

Remote software update

See *Remote software upgrade* on page 33.

To update software locally with the web interface

To update the software in the EXPLORER 540, do as follows:

1. Download the new software¹ or acquire the software from Cobham SATCOM and save it to your computer.
2. Connect your computer to the EXPLORER 540.

Note

Connect to the LAN interface of the EXPLORER 540. Depending on your system configuration, you may have to connect through a router or a switch.

3. Open the web interface in your browser.
For details on how to access the web interface, see *To access and navigate the web interface* on page 39.
4. Click  (Control panel) at the bottom of the page.
5. Click **Support > Update software**.
6. Click **Update software...**
7. Browse to the new software version and click **Open**. The file has the extension “.tiif”.
8. The EXPLORER 540 now restarts and completes the software update.

Note

The update procedure takes a couple of minutes.

You can check the software version under **Control panel > Support > About**.

1. You can download the software from the “Self Service Centre” at www.cobham.com/satcom, select **Service and Support > Cobham SATCOM Service and Support** and then **24-7 Self Service Centre / Technical Downloads**. Locate the EXPLORER 540 software.

Reset button

The EXPLORER 540 has a Reset button that has two functions: To restore all settings to factory settings, or to restart the EXPLORER 540.

Note

You can disable or limit the function of the Reset button using the web interface. See *Reset button* on page 73.

The Reset button is located inside the interface enclosure at the back of the terminal and can only be accessed when the cover is removed.

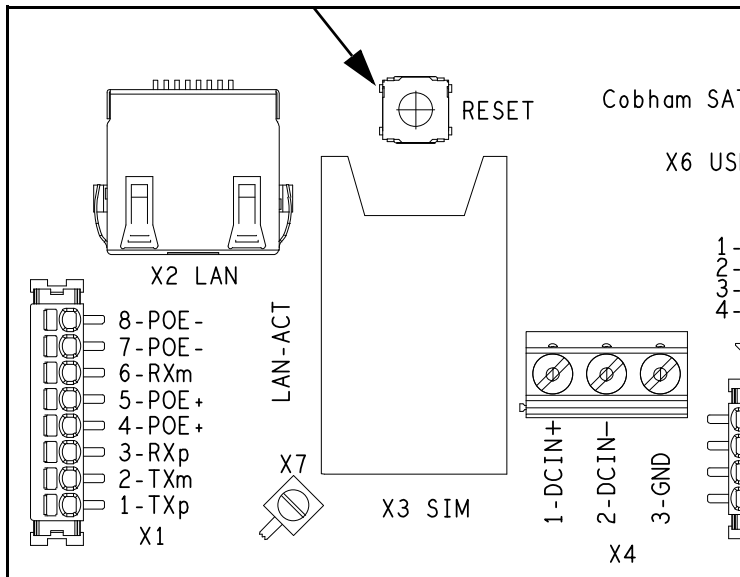

Do as follows:

1. Use the included Torx bit to unscrew the screws holding the cover for the interface enclosure.
2. Locate the Reset button.
3. Use a pointed device to push the Reset button.

Action	Function
Push and hold the Reset button for 2 seconds	The EXPLORER 540 restarts (power cycle) and begins the installation process again.
Push and hold the Reset button for > 10 seconds	The EXPLORER 540 restores factory settings and restarts the system. All changes to the configuration are lost and the administrator password is reset to admin .

4. Close the cover and tighten the screws carefully.
This is important in order to maintain the IP grade of the EXPLORER 540.

Maintenance

Cleaning the EXPLORER 540

Clean the exterior of the EXPLORER 540 with a damp cloth.

Disposal of the EXPLORER 540

Old electrical and electronic equipment marked with this symbol can contain substances hazardous to human beings and the environment. Never dispose these items together with unsorted municipal waste (household waste).



In order to protect the environment and ensure the correct recycling of old equipment as well as the re-utilization of individual components, use either public collection or private collection by the local distributor of old electrical and electronic equipment marked with this symbol.

Contact the local distributor for information about what type of return system to use.

Troubleshooting

Troubleshooting guide

Problem	Possible cause	Remedy
Installation process: The pointing process fails	The view to the satellite is blocked.	Make sure the EXPLORER 540 has a clear view to the satellite. Reboot the terminal to run installation again.
	The antenna is pointed in the wrong direction.	Check that the antenna is pointed according to the position data. Adjust the position to the highest possible signal strength.
Installation process: "Start satellite connection" fails	Missing SIM SIM error Missing PIN Poor satellite signal	Insert SIM Replace SIM card Enter or cancel PIN, see <i>To enter the SIM PIN in the web interface</i> on page 74. Check that the antenna is pointed according to the position data, and that nothing is blocking the line of sight. Adjust the position to the highest possible signal strength.

Problem	Possible cause	Remedy
Installation process: "Verify satellite connection" fails	Wrong APN Wrong link monitoring addresses Network issues	Enter correct APN or select SIM default Enter correct link monitoring addresses, or disable link monitoring to skip ping verification. <i>See Link monitoring on page 66.</i> Try again later. To skip ping verification, disable link monitoring.
The EXPLORER 540 is not operational.	Software error	Restart the terminal. If the problem persists, you can restore to factory defaults as described in <i>Reset button</i> on page 77. Note: This will reset the configuration of your terminal to factory default!
The web interface shows Insert SIM .	The SIM card is not present.	Remove power and Insert the SIM card in the SIM slot according to the instructions in the installation guide.
	The SIM card is not inserted properly.	Remove power and then remove the SIM card and re-insert it according to the instructions in the installation guide.
The web interface shows No position fix .	The EXPLORER 540 is unable to register on the network, because the GNSS position is unknown.	Make sure the view to the GNSS satellites is not blocked. To obtain position fix, the EXPLORER 540 should be placed flat on an even surface pointing straight upwards, with a clear view to as much of the sky as possible. When the EXPLORER 540 has obtained position fix, you can point the antenna towards the BGAN satellite. You can see position status in the Dashboard of the web interface (status section).

Problem	Possible cause	Remedy
The web interface shows Not registered.	The EXPLORER 540 cannot register on the BGAN network.	Check that your SIM card is valid for communication on the BGAN network. Check your subscription with the Airtime Provider.
The web interface shows External control.	The EXPLORER 540 is currently controlled by an external application, e.g. LaunchPad or an AT command interface.	If you want to use the built-in web interface, stop the external application and restart the EXPLORER 540. Then open your browser and access the web interface.
The EXPLORER 540 cannot obtain its position using GNSS.	There is no GNSS signal, or the signal is weak. If the EXPLORER 540 has not been used recently within the same location, it can take up to 10 minutes to obtain the position.	Check the position status in the web interface. To help the EXPLORER 540 obtain position fix, it should be placed flat on an even surface pointing straight upwards, with a clear view to as much of the sky as possible. When the EXPLORER 540 has obtained position fix, you can point the antenna towards the BGAN satellite.
No signal or weak signal from the BGAN satellite.	The view to the satellite is blocked.	Make sure the EXPLORER 540 has a clear view to the satellite. Be aware that window glass may reduce the signal level.
	The antenna is pointed in the wrong direction.	Check that the antenna is pointed according to the position data. Adjust the position to the highest possible signal strength.
Connection to the Internet cannot be established.	The signal strength is too low.	Check that the antenna is pointed according to the position data. Adjust the position to the highest signal strength you can obtain. As a rule of thumb, you should have a signal strength of 45 dBHz or more to be able to make a call or data session.

Problem	Possible cause	Remedy
The web interface cannot be accessed.	The browser is configured to use a proxy server.	For Microsoft Internet Explorer, select Tools > Internet Options > Connections > LAN Settings and uncheck Use a proxy server for your LAN .
	You have entered a wrong IP address.	Check the IP address and re-enter it. The default IP address is 192.168.0.1
A LAN connection cannot be established.	The cable is not properly connected.	Connect the cable.
	The cable type is not correct.	Use Ethernet Min. Cat 5 Solid copper wire, STP. Max. length: 100 m

Status signalling

Means of signalling

The EXPLORER 540 system provides two methods for signalling the status of the system.

- **Light indicator** between the cable glands
- **Messages** shown in the web interface

Light indicator



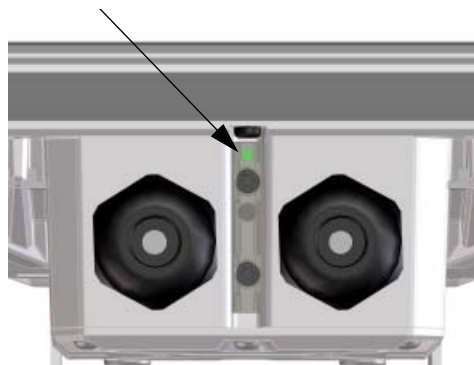





The EXPLORER 540 has one light indicator showing status before and during installation. The Status indicator (LED) is located between the two cable glands.



Note

The LED is only in use until installation is completed, and is **automatically disabled** 10 minutes after the connection is established. The LED is **not enabled again** until you restart the installation process.

Status indicator

Indicator pattern		Meaning
	Green flashing rapidly	Starting up
	Yellow flashing	BGAN pointing
	Green flashing	Verify network connectivity
	Green constant	Ready
	Yellow flashing rapidly	Closing down
	Yellow constant	Warning (user recoverable). See web interface for the warning text.
	Red constant	Error. See the web interface.
	Blue flashing	Uploading software to the terminal Note: The indicator will only flash blue if software upgrade is done before installation. After installation the indicator is disabled.
	Off	Power off or light indicator has been disabled

Event messages and status messages

In the web interface of the EXPLORER 540 you can see status messages and alerts that are currently active.

When a warning or error event is active, the web interface shows a warning symbol . Select it to see a list of currently active alerts.

List of messages

The following list explains some of the messages that may show in the web interface of the EXPLORER 540.

Displayed text	Explanation	Remedy
Standard data speed limited due to high temperature	The bit rate of the data channel is reduced because the temperature is too high.	None
Connection closed. Data or time limit exceeded.	The data connection is closed because a data limit defined in the web interface is exceeded. The data limit may be set to avoid unintentional use of bandwidth, e.g. if you forget to close a connection after use.	Restart the connection e.g. from the Dashboard in the web interface. See <i>Manual activation of data connections</i> on page 29. You can change the data limits in the web interface under Advanced > Data limits.

Displayed text	Explanation	Remedy
Automatic activation failed. Reconnecting...	The terminal failed to automatically activate a Standard data connection at start-up, even though it was configured to do so.	Wait for the terminal to reconnect.
Connection failed	The terminal failed to establish a connection.	Restart the connection e.g. from the Dashboard in the web interface. See <i>Manual activation of data connections</i> on page 29.
Connection lost	The data connection was lost.	Restart the connection e.g. from the Dashboard in the web interface. See <i>Manual activation of data connections</i> on page 29.
Network failure	There is a problem, with the network, e.g. congestion.	Try again later. If the problem persists, contact your airtime provider.
Network failure. Reconnecting...	There is a problem, with the network, e.g. congestion. The terminal tries to reconnect because it is set up for automatic activation.	Wait for the terminal to reconnect. If the problem persists, contact your airtime provider.
Unknown connection problem	There is an unknown problem with the connection.	Restart the connection e.g. from the Dashboard in the web interface. See <i>Manual activation of data connections</i> on page 29. If the problem persists, contact your airtime provider.

Displayed text	Explanation	Remedy
Not registered to the network	The terminal is not registered on the satellite network.	You can only make a connection if the terminal is registered on the satellite network. Make sure that: <ul style="list-style-type: none"> • The SIM card is present. • The PIN has been entered (if used). • The terminal is pointed. See <i>To get started</i> on page 7 for details.
Closing terminal due to high temperature	Critically high temperature is causing the terminal to shut down. The internal temperature has reached 84 degrees Celsius.	None. For information on ambient temperature, see <i>General specifications</i> on page 89. Contact your distributor if the problem persists.
Satellite signal lost	The system no longer receives a signal from the satellite.	Make sure the antenna has a clear view to the satellite.
Registration for voice failed	The system has not yet been allowed to register for voice services (Circuit Switched).	If the problem persists, contact your airtime provider.
Registration for data failed	The system has not yet been allowed to register for data services (Packet Switched).	If the problem persists, contact your airtime provider.
Preparing for software update	The terminal is preparing to update the software.	Wait for the software update to complete.
Error opening software file	A wrong file name may have been entered with the AT command <code>_IUPDFW</code>	Use the command <code>_IUPDFW?</code> to show the correct file name before updating.
Software update is already started	You tried to start a software update when someone else had already started one.	Wait until the software update is completed.
Software version is already installed	You are trying to update the software to a version that is already installed.	Check your existing software version, e.g. in the web interface under Control panel > Support > About .

Displayed text	Explanation	Remedy
Online software update failed	Remote software update failed	Try again later. If the problem persists, contact your distributor.
Online software update failed. Could not establish PDP context.	Remote software update failed because the data connection could not be established. The reason may be: <ul style="list-style-type: none"> • no network resources, • wrong APN, or • no line of sight to the satellite 	Check the status of the terminal, e.g. in the web interface. Make sure there is line of sight to the satellite and that the APN is correct.
Online software update failed. Could not connect to URL.	Remote software update failed because the terminal could not connect to the URL.	Check that you have specified the correct URL in your AT command, or enter the correct IP address instead.
Software update transfer error	An error occurred while trying to transfer the file for software update to the terminal.	Try again later. If the problem persists, contact your distributor.
Software update transfer timeout	The system timed out before the software file was transferred to the terminal.	Try again later.
The terminal is not installed	The terminal has failed in the installation process, or the installation process was cancelled.	If you want to restart the installation process, restart the terminal or access the web interface and select Control panel > Installation.

Log files

With AT commands you can command the EXPLORER 540 to send a diagnostics report or the Event log, System log or AT command log to a specified FTP server. See *Log file(s)* on page 36.

To create a diagnostics report

The diagnostic report contains relevant information for troubleshooting. When contacting your distributor for support, please enclose this file. To generate the report, do as follows:

1. Access the web interface.
2. Select  (Control panel) at the bottom of the page.
3. Select **Support**.
4. From the **Support** page, select **Diagnostics report**.
5. Select **Generate report**.

Note | It may take a few minutes to generate the report.

6. Select **Download report**.
7. Choose a location for the file and save it.

Call log and data log

The log holds detailed information on each call or data session to and from the EXPLORER 540, including date and time, phone numbers, duration, amount of data transferred etc. Date and time is UTC time, received from the satellite.

To see the log in the web interface, select  (Control panel) > **Logs**. See *To use the logs* on page 48.

Event log

The Event log shows events that occurred in the past and are no longer active. It includes events of informational character describing normal phases of operation for the terminal, and also alerts that have appeared in the Alerts list.

To view the event log in the web interface, select **Event log** from the **Support** page.

To view extended status



To see the Extended status page, select  (Control panel) > **Support** > **Extended status**.

To view updated information on the **Extended status page**, select the icon in the top left corner to refresh the page.

The Extended Status page shows IAI-2 status, IMSI number and IMEI number.

To reset the administrator password

If you have forgotten the administrator password, do as follows:

1. Contact your supplier for a reset code.
Report the serial number and IMEI number of the terminal.
You can find the serial number on the label on the EXPLORER 540 or under  (Control panel) > **Support** > **About** and the IMEI number in the web interface under  (Control panel) > **Support** > **Extended status**.
2. After receiving the reset code from your supplier, select **Reset password** from the **Support** page.
3. Type in the reset code obtained from your supplier and select **Reset**.
4. The password is reset to **admin**.

Help desk

Under Help desk you can enter the contact information you want for your EXPLORER 540. The Help desk contact information is empty by default. You must provide the contact information, e.g. the phone number for your Airtime Provider under **Advanced** > **Help desk**. For details on how to enter the information, see *Help desk* on page 73.

The Help desk information is then available from the About page ( (Control panel) > **Support** > **About**)

List of reserved IP subnets

Some IP subnets are reserved for internal use in the terminal. If any of these addresses are assigned to external equipment connected to the terminal, the terminal and connected equipment will not be able to communicate.

The following local IP subnets are reserved for internal use in the terminal. The netmask for all of these subnets is 255.255.255.0.

192.168.1.x

192.168.2.x

192.168.3.x

192.168.4.x

192.168.5.x

192.168.6.x

192.168.7.x

192.168.8.x

192.168.9.x

192.168.10.x

192.168.11.x

192.168.12.x

192.168.13.x

("x" means all numbers from 0 to 255)

Technical specifications

General specifications

Item	Specification
Type	EXPLORER 540, BGAN M2M terminal/ BGAN Class 2 terminal
Max. IP data rate, Rx/Tx ^a Streaming data ^b	464 kbps/448 kbps (simultaneously) 32, 64, and 128 kbps
Voice ^b	Standard voice 4 kbps Premium voice 3.1 kHz audio, 64 kbps
Physical dimensions	202 x 202 x 51.8 mm 8.0 x 8.0 x 2.0 inches
Weight	1.6 kg / 3.5 lbs
Operating temperature Storage temperature	-40 to 75°C , reduced operation ^c -40 to 55°C, full operation -40 to 75°C
Water & Dust	IP66
Environment condition	Outdoor mounting and use in harsh environment
Max. altitude for Hazardous locations	2000 m
Relative humidity	95% humidity non-condensing at 40°C
pollution degree	Pollution degree 2
Supported web browsers (Others may be supported, these have been tested.)	Safari 5.1.7 and above Internet Explorer 9.0 and above Google Chrome 23 and above Mozilla Firefox 16 and above
Approvals	CE, FCC, IC, RCM, GMPCS, C1D2, Russia (Type approval certificate in the field of communication), Japan (Radio law), Inmarsat Class 2 Type Approval and BGAN M2M Certified

a. Performance depends on a wide range of factors and actual usage.

b. Not available for M2M subscription.

c. When the internal temperature reaches 84°C, the terminal closes down. An event message is recorded in the event log.

Interfaces specifications

LAN interface (X1 or X2)

Connector pin-out

Important | There are two LAN connectors, but **only one at a time can be used!**

X1: Terminal block and X7 (GND)

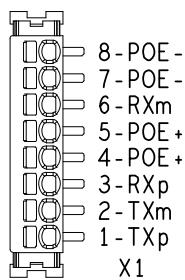

and



or

X2: RJ-45 connector



Female (receptacle)

Pin	Function
1	TXp
2	TXm
3	RXp
4	POE+
5	POE+
6	RXm
7	POE-
8	POE-

Note | If you connect to the terminal block X1 you must connect the shield of the cable to the screw terminal X7 (GND).

To insert the wires in X1 use a screwdriver (max. 2mm wide) to push each terminal open.

Specifications

Item	Specification
Number of connectors	2: X1 or X2 - only one at a time available! The two connectors are on the same electrical interface.
Connector types	RJ-45 female or spring loaded terminals
Standard	ISO/IEC 8877:1992 and PoE+ IEEE 802.3at type 2 class 4 NOTE: The EXPLORER 540 is a Powered Device (PD) , that is it may be powered by PoE from external Power Sourcing Equipment (PSE), but it cannot supply PoE
Power consumption	Power save mode ("wake-on" functions): 800 mW Sleep mode: 3.2 W Transmitting: max. 24 W
Max. data rate	10/100 Mbps

Item	Specification
Max. cable length	100 m / 328 ft with Cat5 UTP

DC power input (X4)

Connector pin-out

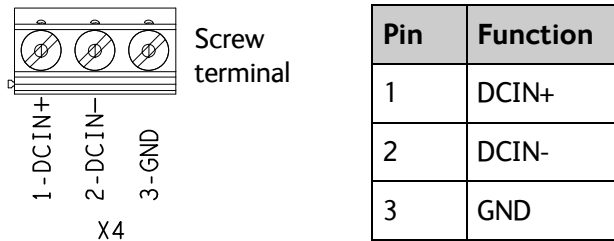

To unscrew and fasten the screws in X4 use a screwdriver (max. 3.5 mm wide). If the DC cable is shielded, connect the shield to pin 3, GND. Otherwise leave GND unconnected.

Specifications

Item	Specification
DC input range (min-max)	10.5 to 32 VDC
DC input, nominal	12 or 24 VDC
Transient overvoltage	Overvoltage category II
Power consumption	Power save mode ("wake-on" functions): 110 mW Sleep mode: 2.5 W Transmitting: max. 21 W
Connector type	Screw terminals

I/O connector (X5)

Connector pin-out

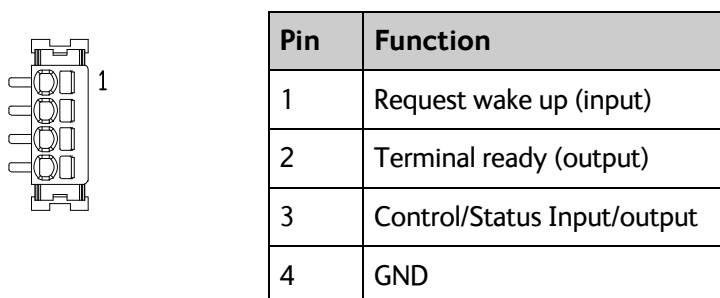

To insert the wires in X5 use a screwdriver (max. 2mm wide) to push each terminal open.
For configuration of the I/O pins, see *Power save (Settings)* on page 71

USB (Host) interface (X6, Future use)

Connector pin-out

USB Micro B	
Pin	Function
1	+5V
2	Dm
3	Dp
4	ID
5	GND

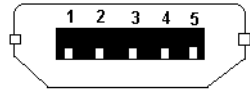

Specifications

Item	Specification
Version	USB v2.0 Host
Connector type	Type Micro B

Built-in BGAN antenna

Item	Specification
Type	Directional patch array, manually adjustable
Polarization	RHCP, Right-hand circular polarization for both tx and rx
Frequencies	
Inmarsat I-4	
Transmit	1626,5 MHz - 1660,5 MHz
Receive	1525 MHz - 1559 MHz
Inmarsat Alphasat (EMEA)	Extended L-band (XL) ^a :
Transmit	1626,5 MHz - 1660,5 MHz and 1668 MHz - 1675 MHz
Receive	1518 MHz - 1559 MHz
GNSS	GPS, GLONASS, Beidou
EIRP	Nominal: 15.1 dBW ±1dB, Class 2
Gain	11.25 dBi

a. Only available within Alphasat coverage (EMEA). See *BGAN services* on page 5.

Outline drawing

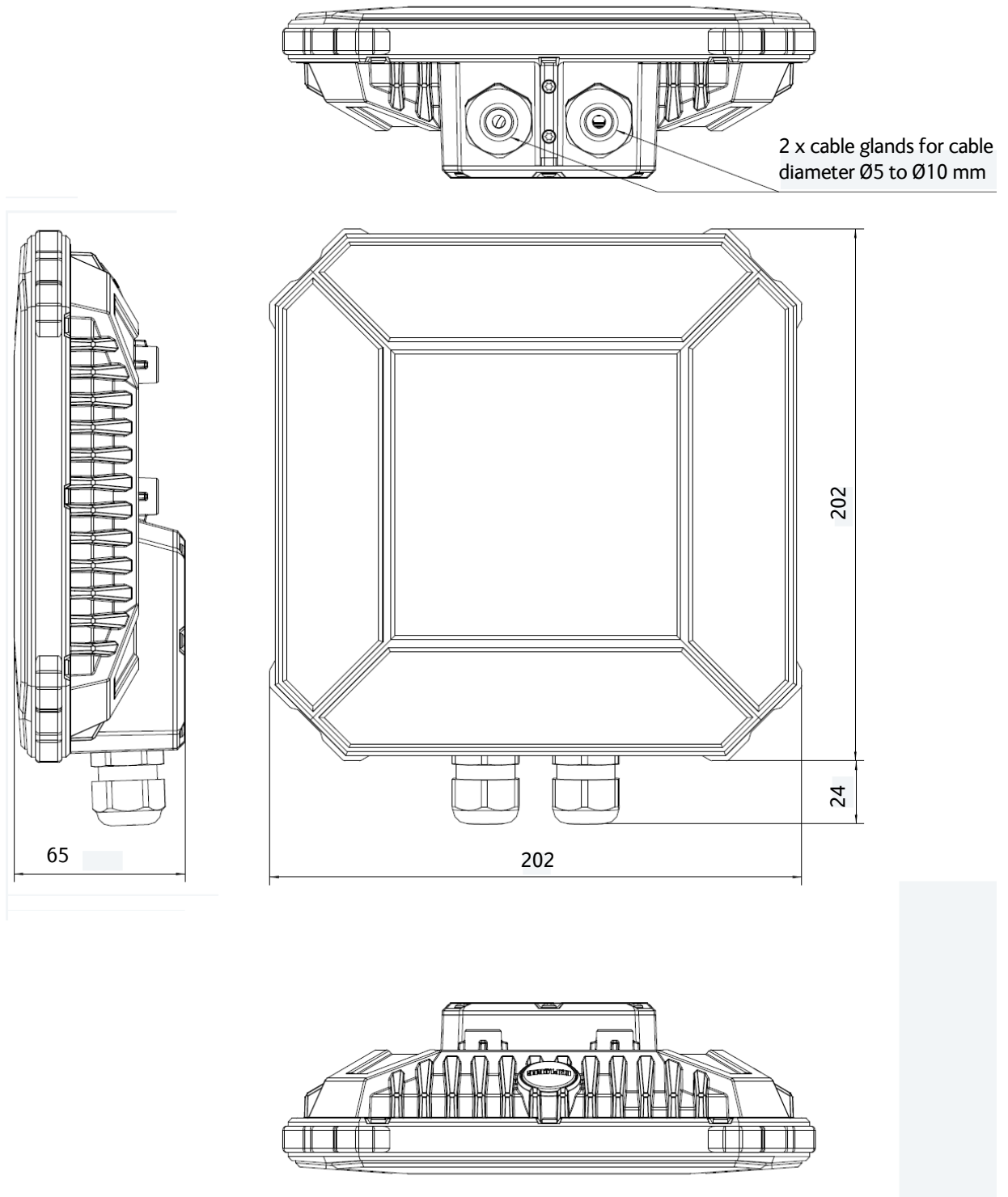

Dimensions are in millimeter

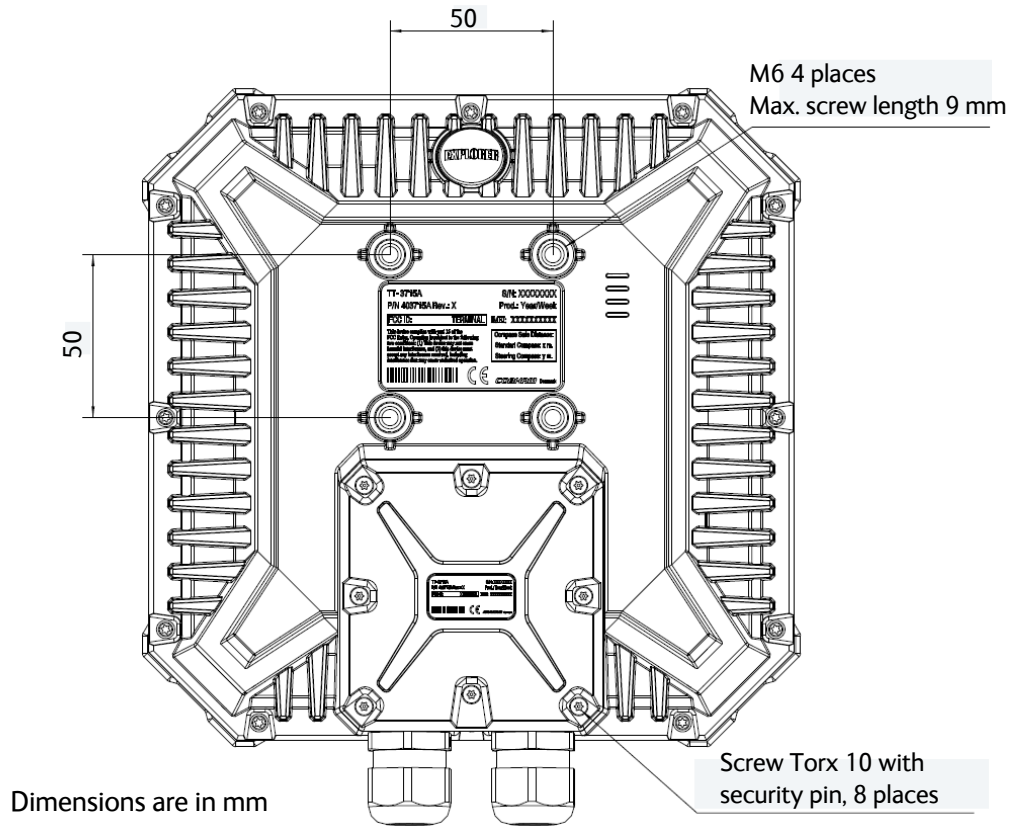

Command reference

This appendix lists the function, syntax and parameters for commands used with the EXPLORER 540. You can send commands to the EXPLORER 540 either with an SMS or with AT commands. SMS is very useful for remote operation, because you only need the terminal's mobile number to access the terminal. There is one section for each type of command:

- *SMS remote commands*
- *AT commands*

SMS remote commands

The following SMS commands are supported:

- *ACTIVATE*
- *DEACTIVATE*
- *CLEAR*
- *GETINFO*
- *RESTART*
- *WATCHDOG*
- *ATCO*
- *ADPWRST*

Syntax conventions

Syntax definitions use the following conventions:

- `<parm>` indicates that a parameter (without `<` and `>`) can be filled in by the user.
- `{ <opt1> | <opt2> | ... | NA }` indicates that one of various options must be chosen by the user. Use **NA** when no value is defined.
- Keywords and parameters are separated by the space (ASCII 32) character.
- The command name and all keywords must be in upper case; most user-provided parameters are case sensitive but may be either case.
- **TE** means Terminal Equipment - the equipment connected locally to the EXPLORER 540.

SMS remote command summary

Commands

The table below summarizes the available SMS remote commands. Empty cells means no parameters and no placeholders (the password comes just after the last parameter).

Command	Parm1	Parm2	Parm	Parm	Parm	Parm	Parm	Password
ACTIVATE	<qos>	<PC/TE type>	<apn>	<user>	<pwd>			<rsms_pwd>
DEACTIVATE	<qos>	<PC/TE type>						<rsms_pwd>
CLEAR	<category>	SMS						<rsms_pwd>
GETINFO	<info_mode>	<dataset>						<rsms_pwd>
RESTART	<reset_type>	BGAN						<rsms_pwd>
WATCHDOG	<wdog_op>	<ping1>	<ping2>	<ping3>	<ping_always>	<ping_interval>	<wdog_enable>	<rsms_pwd>
ADPWRST	1	<imei>						<rsms_pwd>
ATCO	<resp_mode>	<rsms_pwd>	<at_cmd>					

Parameters

The table below summarizes the available parameters for the SMS remote commands.

Parameter	Values	Meaning
<qos>	1	Standard/background data (currently the only qos available for M2M)
<PC/TE type>	DHCP STATIC AWO <name> <IP addr> ANY	All TEs known via DHCP All TEs known via Terminal settings Always On, deactivate all PDP contexts including context established with ACA Name of specific TE, as known by DHCP server IP Address of specific TE (or Global IP for DEACTIVATE) Any/all TEs attached (DEACTIVATE: all except PDP context established with ACA)
<apn>	<APN> NA	APN name, e.g. bgan.inmarsat.com Placeholder when no APN is specified. Default APN is used.
<user>	<APN user name> NA	User name associated with APN Placeholder when no APN user name is specified
<pwd>	<APN password> NA	Password associated with APN username Placeholder when no APN password is specified

Parameter	Values	Meaning
<rsms_pwd>	<rsms_pwd>	Remote SMS password
<category>	1 2 3 4	Delete only Read SMS messages Delete Read and Sent Delete All except Unread Delete All SMS messages
<info_mode>	1 2	For GPS query: position data only. For other queries: use verbose mode (with titles) For GPS query: position data plus SMS usage. For other queries: use terse mode (no titles)
<dataset>	GPS USAGE ALL	GPS position Cumulative call time and data usage GPS position plus call time and data usage
<reset_type>	1	Normal delay restart
<wdog_op>	1 2	Get watchdog configuration Set watchdog parameters
<ping[1/2/3]>	<IP addr> NA	Up to three ping destination IP addresses Placeholder when no IP address is specified
<ping_always>	0 1 NA	Send ping only if no traffic Always send ping, regardless of data traffic Placeholder when no value is specified
<ping_interval>	<integer> NA	Interval between pings (minutes) Placeholder when no value is specified
<wdog_enable>	0 1 NA	Disabled Enabled Placeholder when no value is specified. The existing setting applies. Used if you want to change one of the other parameters without changing the enabled/disabled setting.
<imei>	<14 digits>	IMEI of the EXPLORER 540, without dashes or check digit
<resp_mode>	0 1 2 3	None – send no responses to AT commands Immediate - immediate responses, but not unsolicited Final – suppress immediate if OK, plus unsolicited All – send both immediate and unsolicited responses
<at_cmd>	<at_cmd>	AT command, without prefix AT. For supported AT commands, see <i>ATCO commands</i> on page 100.

SMS reject responses

Reject Response SMS	Possible Cause
WRONG PASSWORD	Authentication Failure
ATCO ERROR	Unable to send AT command to ATC handler
COMMAND NOT SUPPORTED	Attempt to use an SMS command not supported by the target platform
WRONG QOS	Invalid QoS Requested (only a QoS of 1 is valid).
WRONG CONNECTION TYPE(NO DHCP TE)	No DHCP TEs connected to the Remote Unit
WRONG CONNECTION TYPE(NO STATIC TE)	No Static TEs added in Terminal settings
WRONG CONNECTION TYPE(NO TEs)	No TEs are connected to the Remote Unit
ACT/DEACT PARM PROBLEM	The <IP addr> provided for an ACTIVATE or DEACTIVATE command is incorrect (for ACTIVATE, it must be in same subnet as the EXPLORER 540 IP and not be the EXPLORER 540 IP; for DEACTIVATE, it must exist as a local or global IP address in the existing PDP table).
INVALID RESTART REQUEST	Attempt to perform restart before EXPLORER 540 has been running for at least 15 minutes
INVALID WATCHDOG PING ADDRESS	Entered Ping address is out of range (0.0.0.0 – 255.255.255.254)
INVALID WATCHDOG PING FREQUENCY	Requested Ping Frequency is less than the minimum (5 minutes)
INVALID WATCHDOG REQUEST	"Ping required" or "wdog enabled" fields incorrect in remote SMS message, or watchdog request other than "get" attempted
ERROR: TERMINAL BUSY	An ACTIVATE or DEACTIVATE command is in progress

AT commands

The following most used AT commands are explained in this manual. Other AT commands not mentioned here may still be supported.

Syntax conventions

Syntax definitions use the following conventions:

- `<parm>` indicates that a parameter (without `<` and `>`) can be filled in by the user.
- `{ <opt1> | <opt2> | ... | NA }` indicates that one of various options must be chosen by the user. **NA** means no value is defined.
`[<options>]` indicates that `<options>` may or may not be included in the command.
- String parameters must be enclosed in double-quotes (ASCII 34) and numeric parameters must not be. Only the ASCII double-quote is recognized; slanted quotes, e.g. from the Windows-1252 or UTF-8 character sets, are not valid.
- Keywords and parameters are separated by commas.
- The command name and all keywords must be in upper case; most user-provided parameters are case sensitive but may be either case.
- **TE** means Terminal Equipment - the equipment connected locally to the EXPLORER 540.

M2M related AT commands

The tables below summarize some of the most used AT commands for M2M operation. Parameters are explained in *Parameters for other M2M related AT commands* on page 104.

ATCO commands

The table below summarizes the ATCO commands, i.e. AT commands that can be used in the SMS command **ATCO**.

Command	Parm1	Parm2	Parm3	Parm4	Parm5	Parm6	Parm7	Parm8	Parm9
_IGETFW	<mode>	[<ftp server>]	[<ftp username>]	[<ftp passwd>]	[<apn>]	[<apn username>]	[<apn passwd>]		
_IUPDFW	<filename>								
_ISENDFILE	<local dir>	<filename>	<ftp dir>	<ftp server>	<ftp username>	<ftp passwd>	[<apn>]	[<apn username>]	[<apn passwd>]
_IGETFILE	<ftp dir>	<filename>	<local dir>	<ftp server>	<ftp username>	<ftp passwd>	[<apn>]	[<apn username>]	[<apn passwd>]
_IUPDCFG	<filename>								
_IREMWEB	<enable>	<ip_addr_lo>	[<ip_addr_hi>]	[<apn>]	[<apn username>]	[<apn passwd>]			
_IATCROBST ^a	<enable>								
_ICPWD	<type>	<old passwd>	<new passwd>						

a. Robustness for 3GPP LTE signals, not ATC

Parameters for ATCO commands

Parameter	Values	Meaning
<mode>	0 1	Deferred activation Immediate activation
<ftp server>	<ftp server> NA	Host name or IP address of the ftp server Placeholder when no ftp server is specified. Default ftp server is used.
<ftp uname>	<ftp uname> NA	User name for the ftp server Placeholder when no ftp server is specified
<ftp passwd>	<ftp passwd> NA	Password for the ftp server Placeholder when no ftp server is specified
<apn>	<apn> NA	APN name Placeholder when no APN is specified. The default APN from the SIM is used.
<apn uname>	<apn uname> NA	User name for the APN Placeholder when no APN is specified
<apn passwd>	<apn passwd> NA	Password for the APN Placeholder when no APN is specified
<filename>	<filename>	The name of the file to use, including extension
<local dir>	<local dir>	The name of the local directory in the EXPLORER 540 to use for getting or saving a file
<ftp dir>	<ftp dir>	The name of the directory on the ftp server to use for getting or saving a file
<enable>	0 1	Disable Enable
<ip_addr_lo>	<ip_addr_lo>	IP address of the HTTP client that should be allowed remote access to the EXPLORER 540, or, the lowest address in a range of IP addresses, if a range of addresses is allowed.
<ip_addr_hi>	<ip_addr_hi>	The upper IP address of a range of allowed IP addresses. This parameter is optional; if omitted, only the specified single IP address <ip_addr_lo> may access the EXPLORER 540.
<type>	AD RS	The type of password is administrator password The type of password is remote SMS password
<old passwd>	<old passwd>	The old password that is already in the system
<new passwd>	<new passwd>	The new password to be used after this command. Note that quotes (") and commas (,) and spaces () are not allowed.

ATCO response codes

The following response codes apply to the AT commands supported by SMS.

Code	Text	Explanation
General codes		
0	Complete	Operation completed successfully
1	Unexpected software error	Software error
2	Local file open error	_IGETFILE: could not open local file after download _ISENDFILE: could not open local file _IUPDCFG: Loading configuration failed. Incompatible file format.
3	Directory not found	Could not find specified directory on local file system.
4	File not found	Could not find specified file name on local file system.
5	Error renaming file	Could not restore after failed upgrade.
Context Management codes		
13	Context activation error	Context activation failed. Could be problem with PS attach, SIM subscription, APN, network or connectivity.
FTP Management codes		
20	FTP hookup fail	Connection to FTP server failed. Problem could be server unreachable or specified IP address or server name invalid, or connectivity failure.
21	FTP login fail	FTP user name or password incorrect
23	FTP 'cwd' fail	Could not change to working directory on FTP server.
24	FTP data connection fail	Could not establish an FTP data connection with the server.
26	FTP xfer command fail	Could not initiate data transfer on an established connection. May be caused if filename not found.
29	FTP socket fail	Error while reading or writing FTP data socket.
31	FTP xfer timed out	FTP client timed out waiting for socket ready (read or write), e.g. due to loss of connectivity during transfer.
_IGETFW command codes		
40	File in use, cannot download	The file to be downloaded is the same as the image currently in use.
41	Starting immediate upgrade...	Normal success. File downloaded successfully, now starting immediate update.

Code	Text	Explanation
_IUPDFW command codes		
50	New firmware file not found	Could not find specified filename.
51	New firmware file corrupt	New firmware file corrupt.
52	New firmware file failure	The new firmware failed to run or failed to acquire the network and the unit fell back to the old release.
54	Upgrade status file error	Previous update has not finished yet.
_IREMWEB command codes		
81	Global IP: <ip_addr>	REMWEB connection set up successfully. Indicates global IP address assigned to the EXPLORER 540's own PDP context, to which an HTTP connection may be made.

Other M2M related AT commands

Command	Parm1	Parm2	Parm3	Parm4
_ISMSRMT	<enable>			
_ICLCK	<type>	<enable>	<passwd>	
_IPWSAVSCHED	<psmode>	<psvalue>		
_IMACLOC	<enable>	<interface>	[<interface>]	
_IMACLOCAD	<action>	<interface>	<MAC Address>	[<MAC Address>] ^a
_ITGPIO	<active>			

a. Up to 10 MAC addresses may be specified.

Parameters for other M2M related AT commands

The table below summarizes the available parameters for the AT commands for M2M operation.

Parameter	Values	Meaning
<enable>	0 1	Disable Enable
<passwd>	<passwd>	The existing administrator password
<psmode>	IDLE_TRG TOD_TRG	The power save mode to be set up is “idle trigger”, that is the time with no activity before entering power save mode The power save mode to be set up is “time of day”, that is a specific time of day where the EXPLORER 540 wakes up from power save mode.
<psvalue>	<idle-minutes> <HH:MM>	Used with IDLE_TRG (above). Number of minutes (e.g. 15) Used with TOD_TRG (above). Time of day (e.g. 23:30)
<interface>	0	0 means Ethernet interface. This is the only option.
<action>	0 1	Delete Add
<MAC Address>	<MAC Address>	MAC address(es) for MAC locking. Up to 10 MAC addresses are permitted.
<active>	0 1	Inactive. The GPIO pin is in its inactive state. Active. The GPIO pin is in its active state.

Context management AT commands

The table below summarize some of the most used AT commands for context management. Parameters are explained in the table in the next section.

Command	Parm1	Parm2	Parm3	Parm4	Parm5	Parm6	Parm7
+CGDCONT	<cid>	<protocol>	<apn>	<apn uname>	<apn_passwd>		
+CGEQREQ	<cid>	<Traffic Class>	<Max bitrate UL>	<Max bitrate DL>	<Guaranteed bitrate UL>	<Guaranteed bitrate DL>	
+CGEQMIN	<cid>	<Traffic Class>	<Max bitrate UL>	<Max bitrate DL>	<Guaranteed bitrate UL>	<Guaranteed bitrate DL>	
+CGTFT	<cid>	<packet filter identifier>	<evaluation precedence index>	<source addr & subnet>	<protocol number>	<destination port range>	<source port range>
+CGDSCONT	<cid>	<p_cid>					
+CGACT	<state>	<cid>					
+CGPADDR	<cid>						

Parameters for context management AT commands

The table below summarizes the available parameters for the AT commands for context management.

Parameter	Values	Meaning
<cid>	<cid>	The Context Identifier (1 – 11) for the PDP context
<protocol>	<protocol>	The transport protocol (IP or PPP)
<apn>	<apn> NA	APN name Placeholder when no APN is specified. The default APN from the SIM is used.
<apn uname>	<apn uname> NA	User name for the APN Placeholder when no APN is specified
<apn passwd>	<apn passwd> NA	Password for the APN Placeholder when no APN is specified
<Traffic Class>	1 3	Streaming (not available for M2M subscription) Standard data (Background)
<Max bitrate UL>	<Max bitrate UL> NA	The maximum bit rate up link (32, 64, 128) Placeholder when Standard data is selected
<Max bitrate DL>	<Max bitrate DL> NA	The maximum bit rate down link (32, 64, 128) Placeholder when Standard data is selected

Parameter	Values	Meaning
<Guaranteed bitrate UL>	<Guaranteed bitrate UL> NA	The guaranteed bit rate up link (32, 64, 128) Placeholder when Standard data is selected
<Guaranteed bitrate DL>	<Guaranteed bitrate DL> NA	The guaranteed bit rate down link (32, 64, 128) Placeholder when Standard data is selected
<packet filter identifier>	<packet filter identifier>	The packet filter identifier (1 – 8)
<evaluation precedence index>	<evaluation precedence index>	The evaluation precedence index defines the order in which the traffic flow filters are applied to packets. 0 is first, then 1, 2 etc.
<source addr & subnet>	<source addr & subnet>	This is an IPv4 IP address and subnet mask. (0.0.0.0.0.0.0 to 255.255.255.255.255.255.255)
<protocol number>	<protocol number>	This number is uniquely assigned for the protocol being used. TCP is set to 6, and UDP is set to 17. The protocol number determines which protocol is used by the traffic flow filter. (0-255)
<destination port range>	<destination port range>	Destination port range in the form From.To To indicate only one port number, type in the same port number under From and To. Example: 65333.65338 indicates port numbers from 65333 to 65338, both included.
<source port range>	<source port range>	Source port range in the form From.To See above for example
<p_cid>	<p_cid>	The primary context to which the secondary context is related
<state>	0 1	Deacativate Activate

Message (SMS) configuration AT commands

The following AT commands are used for configuration of SMS.

Note For details on parameters for the message configuration commands, see the 3GPP standard ETSI TS 127 005 V4.2.1.

Command	Parm1	Parm2	Parm3	Parm4	Function
+CSMS	<service>				Select Message Service
+CPMS	<mem1>	[<mem2>	[<mem3>]		Preferred Message Storage
+CMGF	<mode>				Message Format
+CSCA	<sca>	[<tosca>]			Service Center Address
+CSMP	[<fo>	[<vp>	[<pid>	[<dc>]]]	Set Text Mode Parameters
+CSDH	<show>				Show Text Mode Parameters
+CNMI	[<mode>	[<mt>	[<bm>	[<ds>]]]	New Message Indications to TE
+CMGL	<stat>				List Messages
+CMGR	<index>				Read Messages
+CMGS	<da/mr>	[<tda/scts>]			Send Message
+CMGD	<index>				Delete Message

BGAN non-M2M functions

This appendix includes the features and functions in the EXPLORER 540 that are **not** available with an M2M subscription, but only with a standard BGAN subscription.

These functions are:



- Streaming
- VoIP

To control data connections from web interface (BGAN)

The startup page of the web interface is used to start and stop data connections and to set up the data connections.

The difference from the M2M version is, that Streaming connections are supported.



To start and stop data connections

Note The icons for starting  and stopping  connections are only displayed if the terminal is ready and registered on the BGAN network. Otherwise you cannot start data connections.

To start and stop data connections on your EXPLORER 540, do as follows:

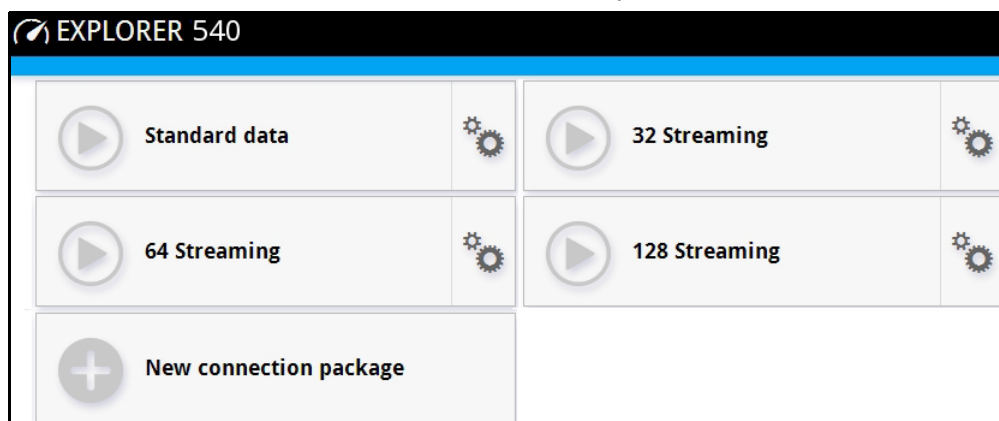
1. In the opening page, locate the connection package you want to start.



2. Click  to start the connection. If more connections are included in the connection package, this will start all included connections. The connections icon at the bottom of the page shows  when a BGAN data connection package is running.

Note Once a Streaming connection is started, the connection will run until you stop it. You will be charged for the time you are connected.

3. Click  to stop the connection.

If the connection fails, the connection tile shows an exclamation mark  and an error message. The error message is also shown in the data log, see *Data log* on page 48.

When a connection is active, the icon changes to  and the tile for the active connection shows:

- IP address: The IP address that has been assigned by the service provider to this session.
- Transferred data: For Standard data, the tile shows the total amount of transmitted and received data since the connection was established.
- Connection duration: For Streaming data, the tile shows the total time the connection has been active.
- Bit rate: For Streaming connections, the tile shows the fixed bit rate.

Default data connection types

By default, the following connections are available:

Name	Type of connection
Standard data	Several users can share the data connection. This type of connection is ideal for TCP/IP traffic such as e-mail, file transfer, and Internet/intranet access. The user pays for the amount of data sent and received.
Streaming data The following Streaming classes are available: 32, 64, or 128 Streaming	An exclusive, high-priority connection, ensuring seamless transfer of data. This type of connection is ideal for time critical applications like live video over IP. The user pays for the duration of the connection. Note that Streaming is not available in M2M subscriptions.

You can use these connections as they are or build your own connection packages. For set up of the connection packages, see the next section.

To set up data connections

To create a new connection package

Do as follows:

1. Click **New connection package**.

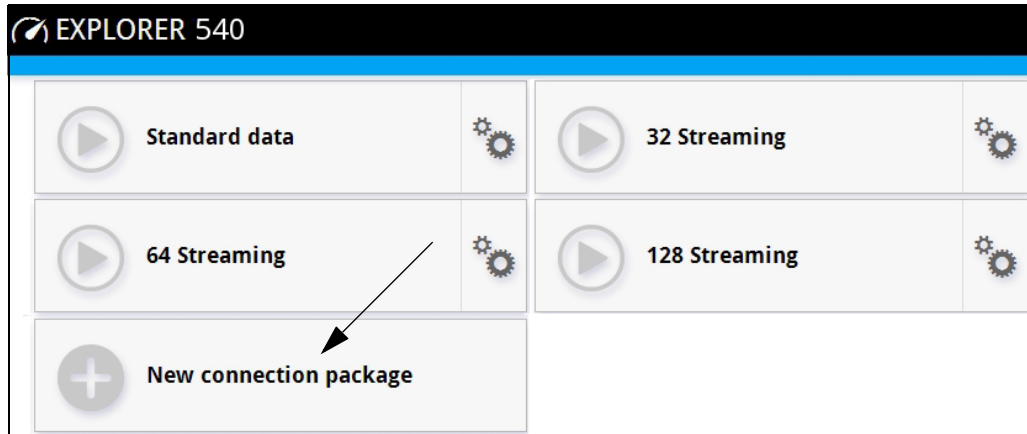

2. Type a name for the new package and click **Save**.
3. Click **Click here to create connections**.

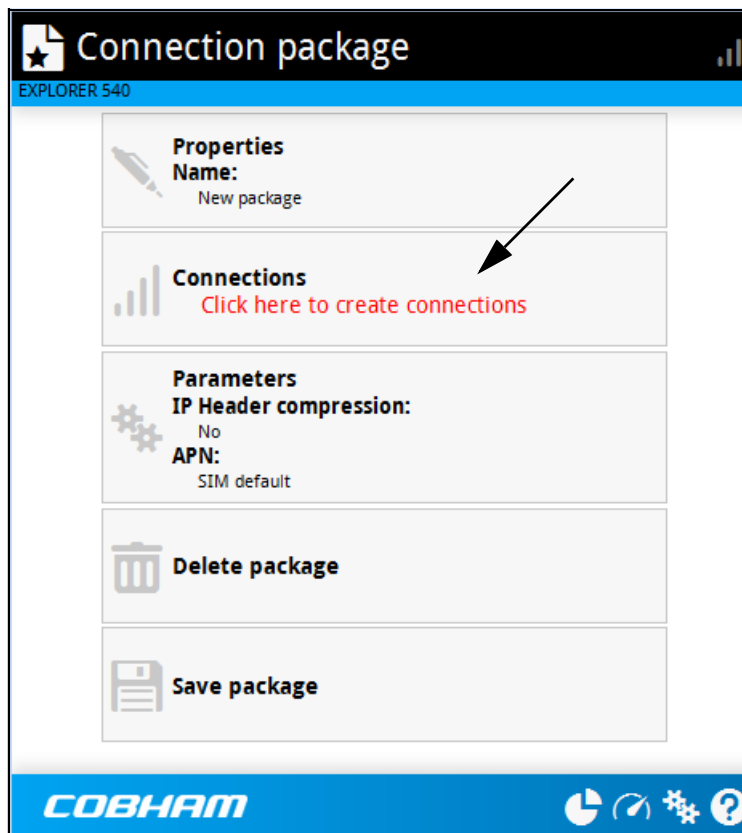

4. Select the connection type you want for your new connection package. You can select Standard, Streaming 32 kbps, Streaming 64 kbps or Streaming 128 kbps.

5. Click **Save package**.

The new package should now appear as a new tile on the startup page.

For details on **Parameters** (APN and IP Header compression) see *To change the APN for a connection package* on page 43.

To make phone calls over BGAN (not M2M version)

Note

Phone calls are only possible if:

- The EXPLORER 540 is connected to the BGAN satellite network, and
- The airtime subscription is a class 2 subscription (not M2M)

To connect a VoIP phone or smartphone

Your VoIP phone or smartphone can be set up to make and receive calls over the BGAN network, using the terminal's phone number.

Note

Make sure your VoIP phone has an integrated SIP client. The EXPLORER 540 has an integrated SIP server.

To connect your phone for making calls

For details on initial setup of your VoIP phone and the EXPLORER 540, see

- The documentation for your handset
- *First time SIP setup* on page 112
- *To manage VoIP phones or smartphones* on page 114

To connect a VoIP phone, do as follows:

1. Start up the EXPLORER 540 terminal.
2. Connect your phone via a router/switch to the LAN interface on the EXPLORER 540¹.

When the VoIP phone is powered and ready, you are able to make and receive calls over BGAN.

1. Since there is only the one LAN interface and the EXPLORER 540 cannot provide power, you must connect the phone(s) via external equipment such as a router (wired or wireless) or a switch.

First time SIP setup

If it is the first time you connect your phone to the EXPLORER 540 for making calls, you must first set up the SIP server details in your phone. For information how, see the user documentation for your phone. You may be asked to enter some of the following details:

- SIP server address and port: Default address: 192.168.0.1, Port: 5060
- User name: Local number in EXPLORER 540 (0501 to 0516)
- Password: Default same as user name
- Codec priority: Highest priority codec type: G.711

Note

The user name and password must match the IP handset settings in the EXPLORER 540. See *To manage VoIP phones or smartphones* on page 114.

Call types

Definition

The phone connection can be a **Standard voice** connection or a **3.1 kHz audio** connection.

- For **outgoing calls**, the call type is **Standard voice** by default. You can change the call type for your call to 3.1 kHz audio by dialling **2*** before the number.

Example: 2*004539558800

- For incoming calls, you can set up in the web interface (IP handset page) which call types you want to receive on your smartphone or IP handset. Only the call types selected for a smartphone/IP handset are received. By default all, call types are accepted.

When receiving calls, the mobile number determines which call type is used. In your airtime subscription you have one number for 3.1 kHz audio and one number for Standard voice. Remember that the call is only received on your phone if the call type used is selected for that phone (called IP handset in the web interface).

For information on how to set up the call types in the web interface, see *To manage VoIP phones or smartphones* on page 114.

To make or receive a phone call with EXPLORER 540

Connect your smartphone or IP handset as described in *To connect a VoIP phone or smartphone* on page 111.

To make a call from the EXPLORER 540

To make a call, dial **00 <country code> <phone number>** followed by off-hook key.

Example: To call Cobham SATCOM in Denmark (+45 39558800), dial **00 45 39558800**

If there was an error establishing the connection, the web interface of the EXPLORER 540 shows an error message.

To receive a call

By default, all phones connected to the EXPLORER 540 will ring when one of the mobile numbers is called. Note however, that this depends on the call type settings. See *Call types* on page 112.

Information on missed calls is stored in the call log. You can see the call log in the web interface (**Control panel**  **> Logs > Call log**).

To make a call to the EXPLORER 540

To make a call to a phone connected to the EXPLORER 540, dial + **<Mobile number>**

- + is the prefix used in front of the country code for international calls. This is **00** when calling from countries in Europe and from many other countries.
- **Mobile number**. The first part of the mobile number is always 870, which is the “country code” for the BGAN system. For information on the mobile numbers, refer to your airtime subscription.

Note | There are two mobile numbers, one for **3.1 kHz audio** and one for **Standard voice**.

Local numbers and special functions

Overview

There are a number of local numbers and dialing functions available in the EXPLORER 540.

The following list shows the allocated local numbers and special-purpose numbers for the EXPLORER 540.

Number	Function
0 followed by one of the numbers 501-516 and off-hook key	Local call to one smartphone or IP handset.
0900 followed by off-hook key	Local call broadcast to all connected phones.

Apart from the numbers above, the EXPLORER 540 uses the following dialing prefixes:

- **1*** before the phone number will force the connection to use **Standard voice**.
- **2*** before the phone number will force the connection to use **3.1 kHz audio**.
- **#31#** before the phone number will hide the callers phone number to the recipient.
- ***31#** before the phone number will show the callers phone number to the recipient where it would otherwise be hidden, e.g. because the number is an ex-directory number.

To manage VoIP phones or smartphones

Overview

This section describes how to manage VoIP phones or smartphones connected to the EXPLORER 540.

The terminal supports connection of up to 16 phones through the LAN interface. Each phone must have a local number in the range 0501 to 0516 as well as a unique password. For details, see the next section.



For details on SIP settings and how to connect your phone to the LAN interface, see *To connect a VoIP phone or smartphone* on page 111.

To manage VoIP phones or smartphones in your EXPLORER 540

Do as follows:

1. Connect your smartphone or your VoIP phone via a router/switch to the LAN interface. For details, see *To connect a VoIP phone or smartphone* on page 111.
2. In the web interface, select  (Control panel) > **IP handsets**.
3. Click the tile for the handset number you want to manage.
4. Select **Enable** to enable the handset.

Note | It may take some seconds to enable the handset.

-  on the tile for your handset means the handset is **disabled**.
 -  on the tile for your handset means the handset is **enabled**.
5. To change the **Password**, simply type in the new number.
 6. Set the call type for incoming calls.
You can select **Standard voice** or **3.1 kHz audio** or both.
 - If you select both, the handset will react (ring) on incoming calls.
 - If you select e.g. Standard voice, the handset will only react on calls made to the Standard voice phone number.
 7. Select the **Preferred outgoing call type**.
The selected type will be used by default, if possible, for any outgoing call from this handset.
 8. Click **Save**.
 9. In the smartphone or IP handset, enter the local number and the password you just entered in the EXPLORER 540. See the documentation for your handset for details.

Note | The user name is also the local number for the handset.

The handset remains in the list after disconnecting. When the handset is connected again, it is automatically recognized and ready for use, if enabled.

Conformity

CE (R&TTE)

The EXPLORER 540 is CE certified (R&TTE directive) as stated in “Declaration of Conformity with R&TTE Directive” enclosed in electronic copy at the end of this appendix.

IC

This device complies with Industry Canada licence-exempt RSS standard(s). Operation is subject to the following two conditions:

- (1) this device may not cause interference, and
- (2) this device must accept any interference, including interference that may cause undesired operation of the device.

Le présent appareil est conforme aux CNR d'Industrie Canada applicables aux appareils radio exempts de licence. L'exploitation est autorisée aux deux conditions suivantes :

- (1) l'appareil ne doit pas produire de brouillage, et
- (2) l'utilisateur de l'appareil doit accepter tout brouillage radioélectrique subi, même si le brouillage est susceptible d'en compromettre le fonctionnement.

This Class [B] digital apparatus complies with Canadian ICES-003.

Cet appareil numérique de la classe [B] est conforme à la norme NMB-003 du Canada.

FCC

Note: This equipment has been tested and found to comply with the limits for a Class B digital device, pursuant to part 15 of the FCC Rules. These limits are designed to provide reasonable protection against harmful interference in a residential installation. This equipment generates, uses and can radiate radio frequency energy and, if not installed and used in accordance with the instructions, may cause harmful interference to radio communications. However, there is no guarantee that interference will not occur in a particular installation. If this equipment does cause harmful interference to radio or television reception, which can be determined by turning the equipment off and on, the user is encouraged to try to correct the interference by one or more of the following measures:

- Reorient or relocate the receiving antenna
- Increase the separation between the equipment and receiver
- Connect the equipment into an outlet on a circuit different from that to which the receiver is connected
- Consult the dealer or an experienced radio/TV technician for help

NOTICE:

This device complies with Part 15 of the FCC Rules.

Operation is subject to the following two conditions:

- (1) this device may not cause harmful interference, and
- (2) this device must accept any interference received, including interference that may cause undesired operation.

NOTICE:

Changes or modifications made to this equipment not expressly approved by Cobham SATCOM may void the FCC authorization to operate this equipment.

Japanese Radio Law and Japanese Telecommunications Business Law Compliance.

This device is granted pursuant to the Japanese Radio Law (電波法)
and the Japanese Telecommunications Business Law (電気通信事業法)

This device should not be modified (otherwise the granted designation number will become invalid)

Thrane & Thrane A/S

Declaration of Conformity with R&TTE Directive

The undersigned of this letter declares that the following equipment complies with the specifications of EC directive 1999/5/EC concerning Radio & Telecommunications Terminal Equipment.

Equipment included in this declaration

TT-3715A EXPLORER™ 540 Terminal PN = 403715A

Equipment Applicability

The TT-3715A EXPLORER 540 is a fixed terminal that provides data and voice communication through the Inmarsat satellite service. The Inmarsat interface to a satellite has no restriction in use. See the User manual for further information.

Declaration

The safety requirement with respect to the LVD directive 2006/95/EC is met by conforming to the harmonized EU standard EN 60950-1. The protection requirement with respect to the EMC directive 2004/108/EC is met by conforming to the harmonized EU standards ETSI EN 301 489-1 and ETSI EN 301 489-20. Effective use of frequency spectrum is met by conforming to the harmonized EU standard ETSI EN 301 444.

Manufacturer

Thrane & Thrane A/S, Lundtoftegårdsvej 93D, DK-2800 Kgs. Lyngby, Denmark

Place and Date

Kgs. Lyngby, 19. April 2016



Fred Cahill, CEO
Thrane & Thrane A/S



A

ACA Automatic Context Activation

APN Access Point Name. The Access Point Name is used by the terminal operator to establish the connection to the required destination network.

C

CE Conformité Européenne. This term signifies that a CE certified product conforms to European health, environmental, and safety regulations. In short, it makes the product legal to be sold in the European Union.

F

FCC Federal Communications Commission. An independent agency of the United States government, created by Congressional statute to regulate interstate communications by radio, television, wire, satellite, and cable in all 50 states, the District of Columbia and U.S. territories. The FCC works towards six goals in the areas of broadband, competition, the spectrum, the media, public safety and homeland security.

FUP Firmware Upgrade Process

G

GMPCS Global Mobile Personal Communications Services

GNSS Global Navigation Satellite System. A navigation satellite system using the GPS, GLONASS, Galileo or Beidou system.

I

IC Industry Canada (French: Industrie Canada) is the department of the Government of Canada with a mandate of fostering a growing, competitive, knowledge-based Canadian economy.

ICMP Internet Control Message Protocol. An Internet protocol mostly used for diagnostics.

IMEI International Mobile Equipment Identity. A unique number identifying your terminal.

- IMSI** International Mobile Subscriber Identity. A unique number used to identify a mobile subscriber on a wireless network.
- IMSO** International Maritime Satellite Organisation. An intergovernmental body established to ensure that Inmarsat continues to meet its public service obligations, including obligations relating to the GMDSS.
- IP** Ingress Protection. An international classification system for the sealing effectiveness of enclosures of electrical equipment against the intrusion into the equipment of foreign bodies (i.e. tools, dust, fingers) and moisture. This classification system uses the letters "IP"

M

- M2M** Machine-to-Machine. Direct communication between unmanned devices using any communications channel, including wired and wireless.

P

- PDP** Packet Data Protocol. A network protocol used by external packet data networks that communicate with a GPRS network.
- PIN** Personal Identification Number. A code number used to provide access to a system that has restricted access.
- PoE** Power over Ethernet. A standard for combining power supply with transmission of data over the Ethernet. The source unit "injects" power into the Ethernet cable and the power is "picked up" at the connected device.

R

- RCM** Regulatory Compliance Mark. The RCM is a symbol signifying that a supplier has taken the necessary steps to have the product comply with the electrical safety and/or electromagnetic compatibility (EMC) legislative requirements of Australia and New Zealand.
- RF** Radio Frequency. Electromagnetic wave frequencies between about 3 kHz and about 300 GHz including the frequencies used for communications signals (radio, television, cell-phone and satellite transmissions) or radar signals.

S

- SIM** Subscriber Identity Module. The SIM provides secure storing of the key identifying a mobile phone service subscriber but also subscription information, preferences and

storage of text messages.

SIP Session Initiation Protocol. An application-layer control (signaling) protocol for creating, modifying, and terminating sessions with one or more participants. Used e.g. for Internet telephony.

SMS Short Message Service

T

TE Terminal Equipment - the equipment connected locally to the EXPLORER 540.

U

UTC Coordinated Universal Time. The International Atomic Time (TAI) with leap seconds added at irregular intervals to compensate for the Earth's slowing rotation. Leap seconds are used to allow UTC to closely track UT1, which is mean solar time at the Royal Observatory, Greenwich.

A

- access
 - remote, 20
- access to settings
 - limit in web interface, 63
- access using AT commands, 19
- admin password
 - change, 27, 62
 - log in, 62
 - log out, 63
 - reset, 87
 - reset with SMS, 23
- advanced settings, 62
- alerts
 - list of, 82
 - view in web interface, 59
- Alphasat
 - frequencies, 92
- antenna
 - short description, 4
- antenna safety instructions, iv
- APN
 - set up for BGAN, 43
- application examples, M2M, 15
- approvals, 3
- AT commands
 - access with IP, 19
 - for security setup, 27
 - list of, 95
 - local and remote access, 19
- AT commands in SMS, 24
- ATCO commands
 - description, 24
- audio assisted pointing, 13
- automatic activation of data connection, 29, 51
- automatic shut down
 - connection, 67

B

- backup configuration, 34, 65
- battery supply, 16
- BGAN antenna specifications, 92
- BGAN services, 5

C

- call charges
 - estimating in web interface, 67
- call log, 48
- calls
 - make, 112
 - missed, received, outgoing, 48
 - total usage, 48
- CE compliance, 115
- certificates, 3
- charges for calls
 - estimating, 67
- command reference, 95
- compliance, 3
- configuration
 - copy, 34, 65
 - IP handsets and smartphones, 114
 - save or load, 34, 65
 - update from ftp server, 34
- conformity, 115
- connected devices
 - manage, 54
- connection
 - automatic shut down, 67
- connectors
 - DC input, 91
 - USB Host, 92
- contact information, 75
- control
 - local, 18
 - remote, 19
- Control panel, 46
- control/status pin
 - read or set with AT commands, 37

D

- data
 - limits, set, 67
 - log, 48
 - total usage, 48
- data connections
 - automatic activation, 29, 51
 - manual activation, 29
 - start and stop in web interface, 42, 108

- DC input
 - connector, 91
- DC supply, 16
- default IP address, 14, 39
- delivery contents, 8
- devices
 - manage, 54
- diagnostics report
 - create, 59, 86
- disposal, 78
- drawing
 - mechanical outline, 93

- E**
- Event log, 59
- event messages
 - list of, 82
- EXPLORER 540 overview, 3
- extended L-band
 - frequencies, 92

- F**
- factory settings
 - restore, 63
- FCC compliance, 115
- features, 2
- file transfer, 34
- forward port, 53
- frequencies
 - extended L-band, 92
 - I-4, 92

- G**
- GNSS
 - select system, 52
 - troubleshooting, 80
- GPIO pin 3
 - AT command, 37

- I**
- I/O pins
 - application overview, 17
 - specifications, 91
- I/O pins
 - setup in web interface, 72
- I-4
 - frequencies, 92
- IAI-2 status, 60, 86
- IC compliance, 115
- IMEI number, 60, 86
- IMSI number, 60, 86
- included items, 8
- indicator, Status LED, 81
- initial inspection, 7
- installation
 - mechanical, 11
 - process, 12
 - restarting process, 47
- interfaces, 2
 - specifications, 90
- internet connection mode
 - setting, 51
- IP address
 - for web interface, 14, 39
 - local, setting up, 51
- IP addresses, reserved, 88
- IP connection
 - monitoring, 29, 66
- IP handset
 - manage in the terminal, 114
 - SIP settings, 112
 - user name and password, 114
- items included, 8

- L**
- LAN
 - automatic activation of data, 29, 51
 - manual activation of data, 29
- language
 - change in web interface, 52
- LED, 81
- light indicator, 81
- limit
 - allowed kB, 67
 - allowed time, 67
 - data, 67
- limiting user access, 63
- link monitoring, 29, 66
- load configuration, 34, 65
- local control
 - methods, 18

- log
 - of calls, 48
 - of data connections, 48
 - of events, 59
- log in as administrator, 62
- log out as administrator, 63
- logs
 - send to server, 36
- M**
- M2M
 - application examples, 15
- M2M services, 5
- MAC address
 - connected devices, 54
- MAC addresses
 - filtering, 28
 - trusted, 28
- maintenance, 78
- manage connected devices, 54
- manual activation of data connection, 29
- maximum for data, 67
- mechanical drawing, 93
- modem mode, 51
- monitoring the external IP connection, 29, 66
- N**
- navigation in web interface, 41
- navigation system
 - select, 52
- non-M2M services, 5
- O**
- outline drawing, 93
- overview of the EXPLORER 540, 3
- P**
- password
 - change, 62
 - log in, 62
 - log out, 63
 - reset, 87
 - smartphone or IP handset, 114
- permissions
 - setting for users, 63
- phone
 - SIP settings, 112
- phone call, 112
- PIN
 - changing for BGAN, 64
 - enabling or disabling for BGAN, 64
 - enter in web interface, 74
- ping command from the terminal, 29, 66
- PoE injector, 15
- point the antenna again, 47
- pointing
 - audio assisted, 13
 - sound enable/disable, 52
- pointing process
 - restarting, 47
- port forwarding, 53
- position
 - troubleshooting, 80
- positioning system
 - select, 52
- power
 - connector, 91
 - PoE injector, 15
 - separate battery supply, 16
- power save functions, 31
 - daily wake-up, 32, 71
 - GPI pin wake up (input), 72
 - GPO pin Terminal ready (output), 72
 - Idle time, 31, 71
 - power save mode, 31
 - setup in web interface, 71
 - sleep mode, 31
- PPPoE, 30
- R**
- radiation distance, iv
- remote access, 20
 - methods, 19
 - to web interface, 25
 - with AT commands, 19
 - with SMS, 20
- remote management
 - access using SMS, 20
 - access using web interface, 25
 - activation with SMS, 21
 - set up in web interface, 68

- remote SMS commands
 - enable/disable, 28
- remote SMS password
 - change, 28
- remote software upgrade, 33
- repack for shipment, 75
- repoint the antenna, 47
- report
 - diagnostics, 59, 86
- reserved IP addresses, 88
- reset admin password, 23
- Reset button
 - change function, 73
 - location and function, 77
- restore factory settings, 63
- return units, 75
- rights for users
 - in web interface, 63
- router mode, 51

S

- safety instructions, antenna, iv
- safety summary, iii
- save configuration, 34, 65
- save power, 31
- security setup, 27
 - using web interface, 28
 - with AT commands, 27
- services, 5
 - M2M, 5
 - standard class 2, 5
- settings
 - in web interface, 46
 - limit access, 63
 - restore, 63
- SIM card
 - short description, 4
- SIP settings, 112
- smartphone
 - manage in the terminal, 114
 - SIP settings, 112
 - user name and password, 114
- SMS
 - activate data connection, 21
 - ATCO command, 24
 - watchdog, 23
- SMS access, 20

- SMS commands, 95
 - enable/disable, 28
 - list of, 95
 - parameters summary, 96, 105
 - Summary, 96
- software
 - remote update, 33
 - update with web interface, 60, 76
- sound during pointing, 13
- specifications
 - BGAN antenna, 92
 - interfaces, 90
- standard class 2 services, 5
- status, 36
 - view in web interface, 45
- status of satellite connection, 60, 86

T

- total usage, 48
- tracking the terminal
 - setup in web interface, 57
- Traffic control, 54
- transferring files, 34
- troubleshooting, 78
- troubleshooting guide, 78
- trusted MAC addresses, 28
- typography used in this manual, v

U

- update configuration, 34
- update software, 60, 76
 - remote, 33
- usage
 - calls and data, 48
- USB
 - connector, 92
- user interfaces, 4
- user name
 - smartphone or IP handset, 114
- user permissions
 - setting up in web interface, 63

V

- VoIP phones
 - setup, 114

W

warning messages, 59

warranty, 75

watchdog, 29, 66

 with SMS, 23

web interface

 accessing, 39

 change language, 52

 definition, 39

 navigating, 41

what's in the delivery, 8

